

EVOTECH®
P E R F O R M A N C E

www.evotech-performance.com

Honda CB750 Hornet
Tail Tidy Instructions



- Ⓐ 1 x Retro Light
- Ⓑ 1 x Loom Connector No.7
- Ⓒ 1 x M5 x 10 Black Button Head
- Ⓓ 2 x M4 Flange Nuts
- Ⓔ 2 x M4 x 10 Black Button Head
- Ⓕ 2 x No.2 P-clip
- Ⓖ 2 x M6 x 35 Black Button Head
- Ⓗ 2 x Spacer
- Ⓘ 4 x M6 x 16 Black Button Head
- Ⓙ 4 x M6 Flange Nut

EVOTECH[®]
P E R F O R M A N C E

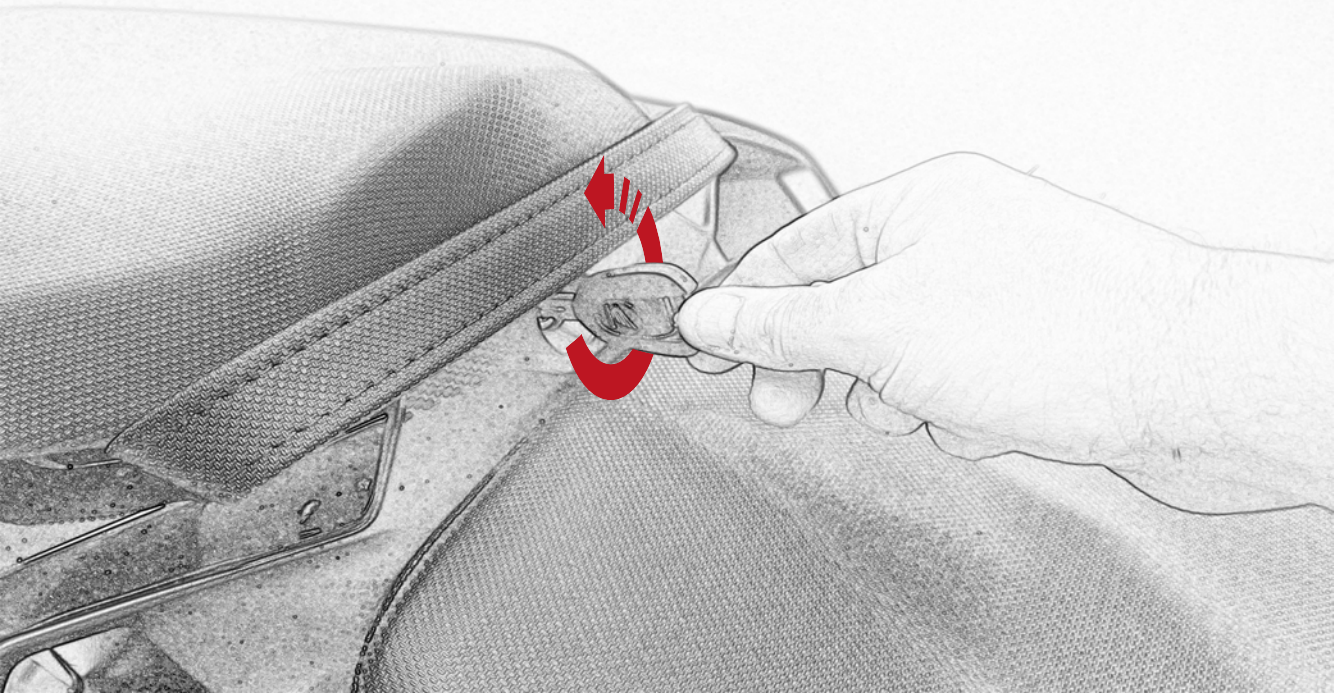

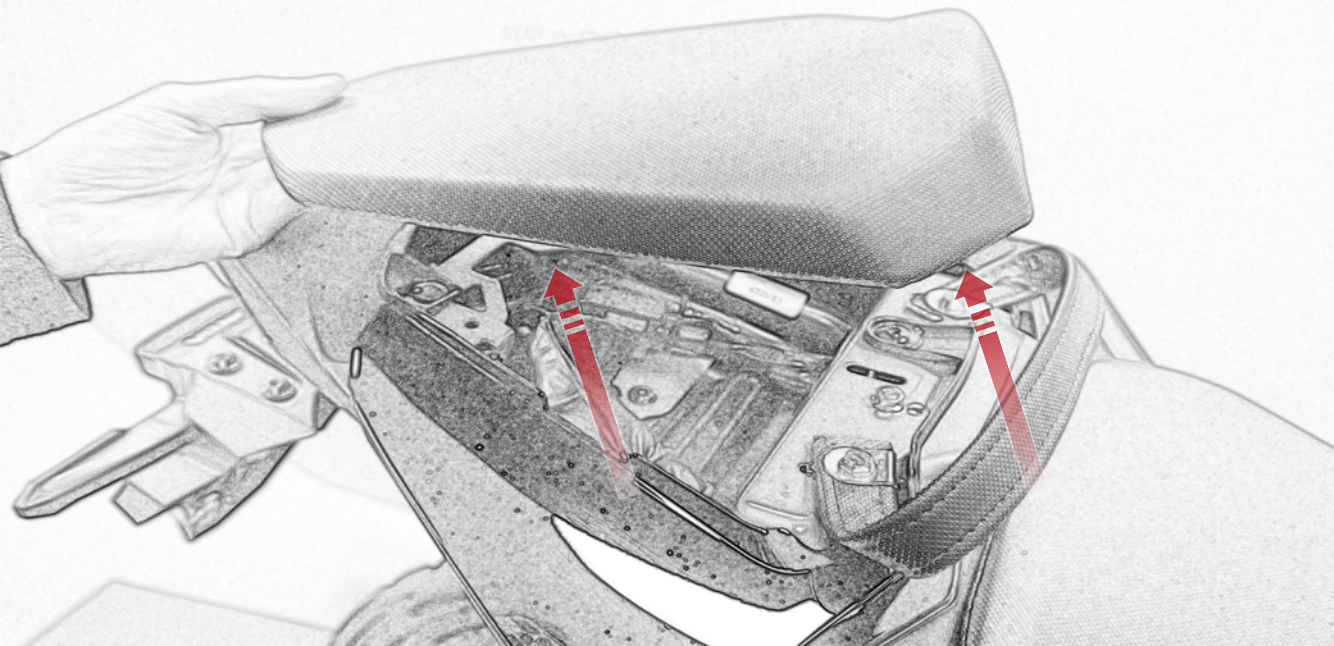

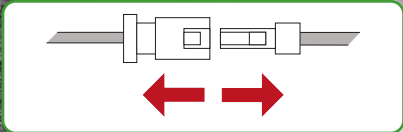
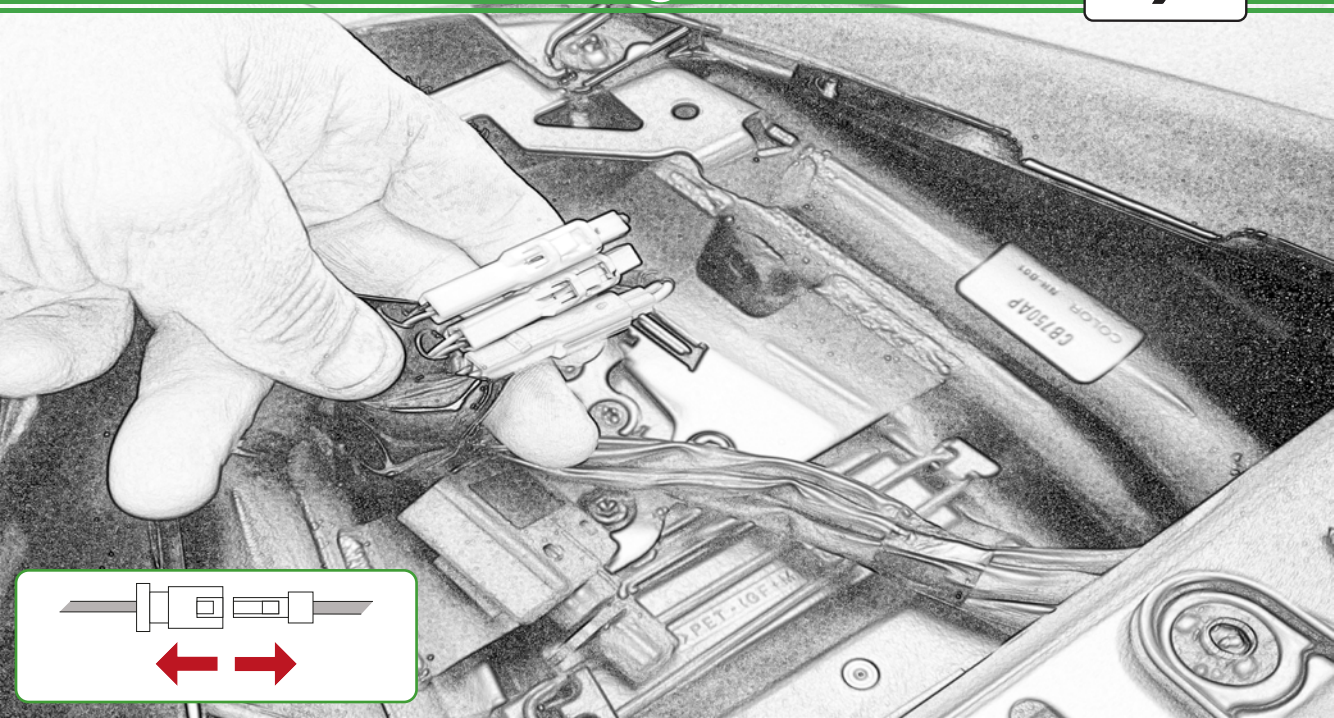

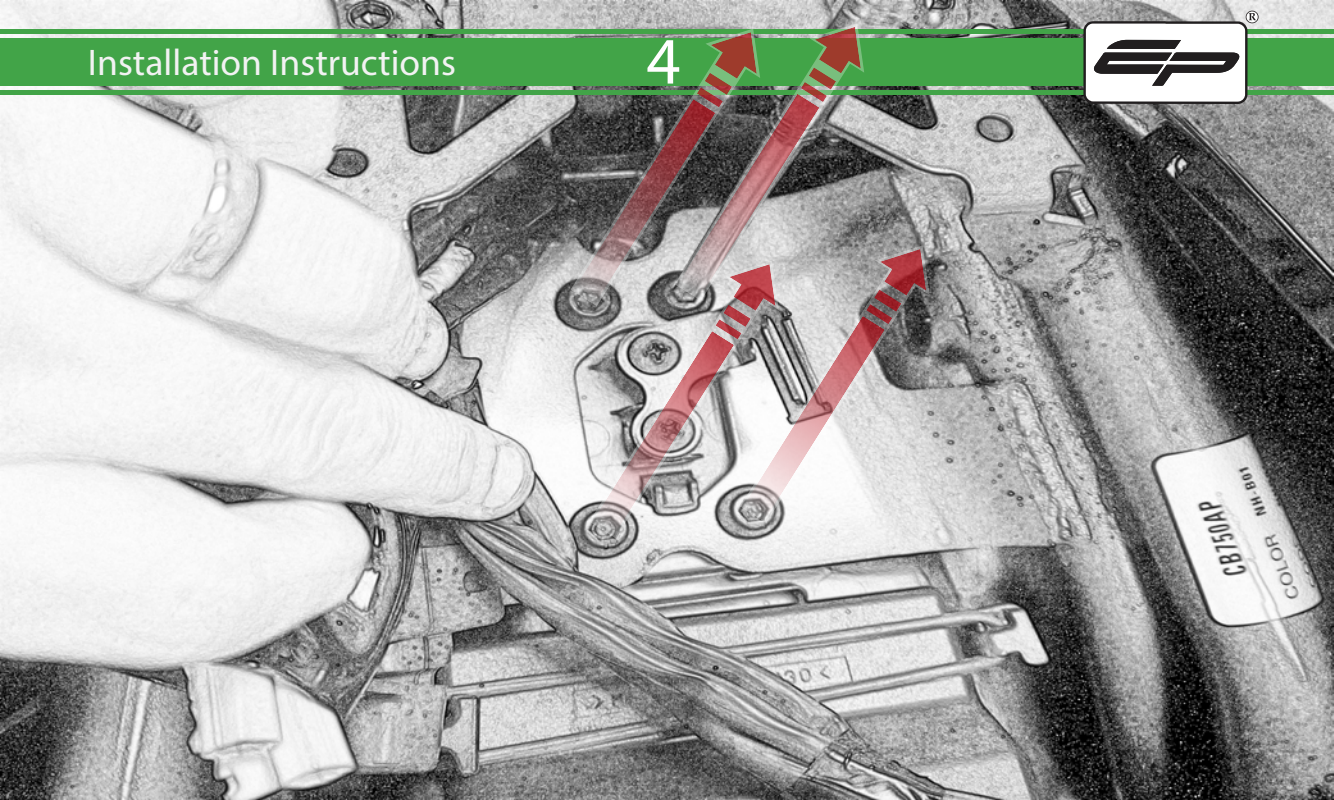

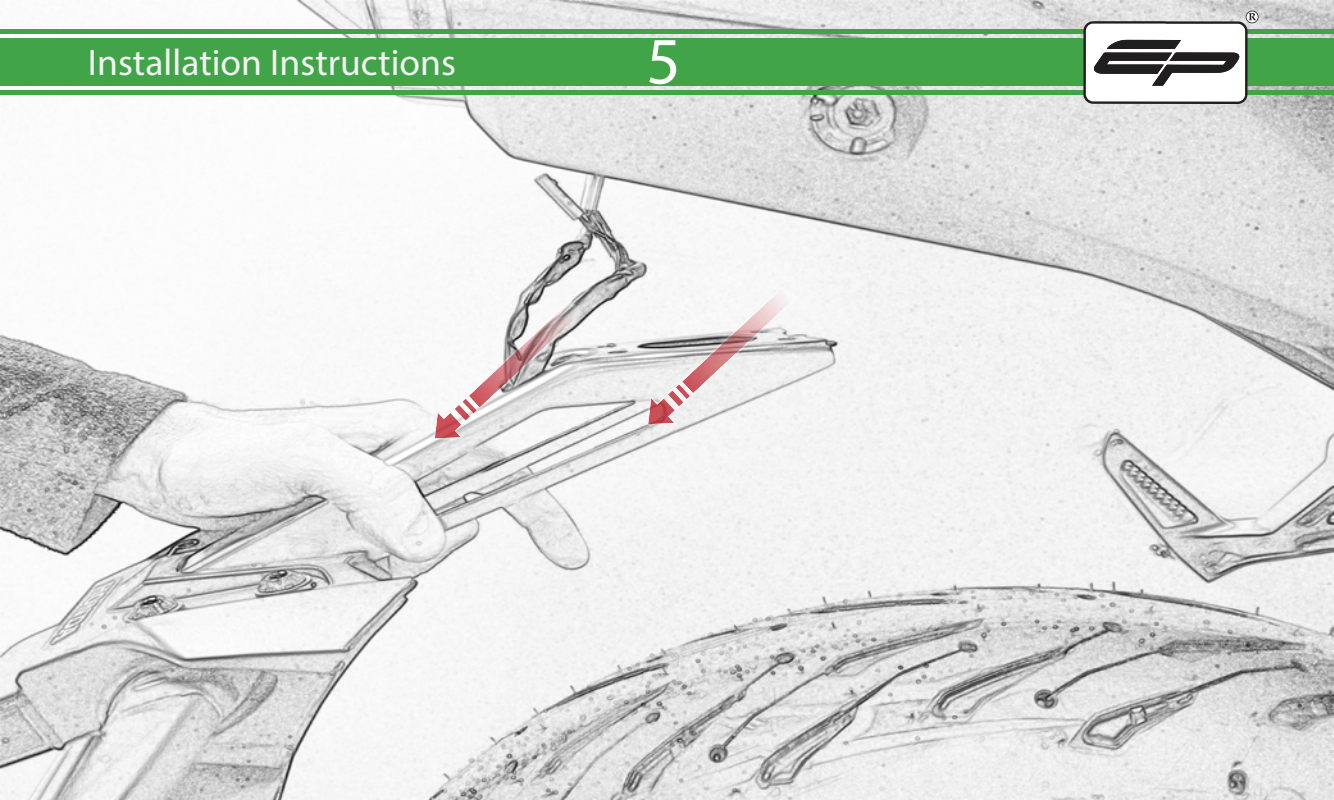

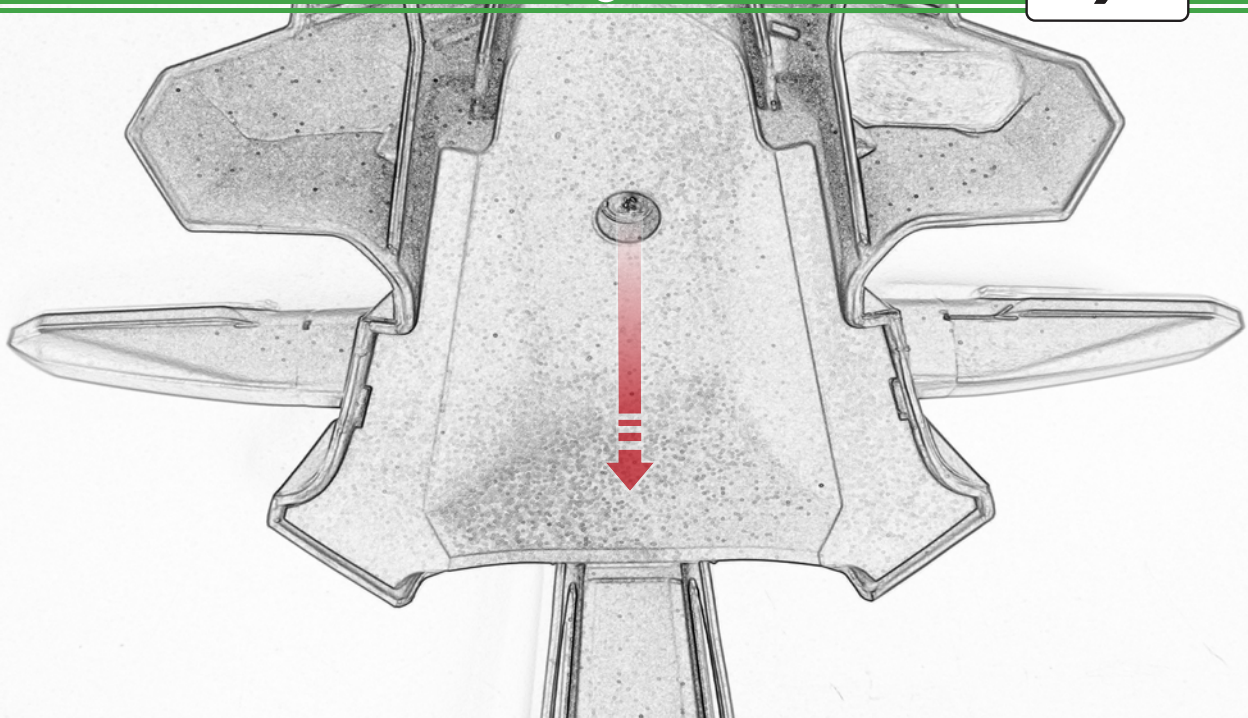

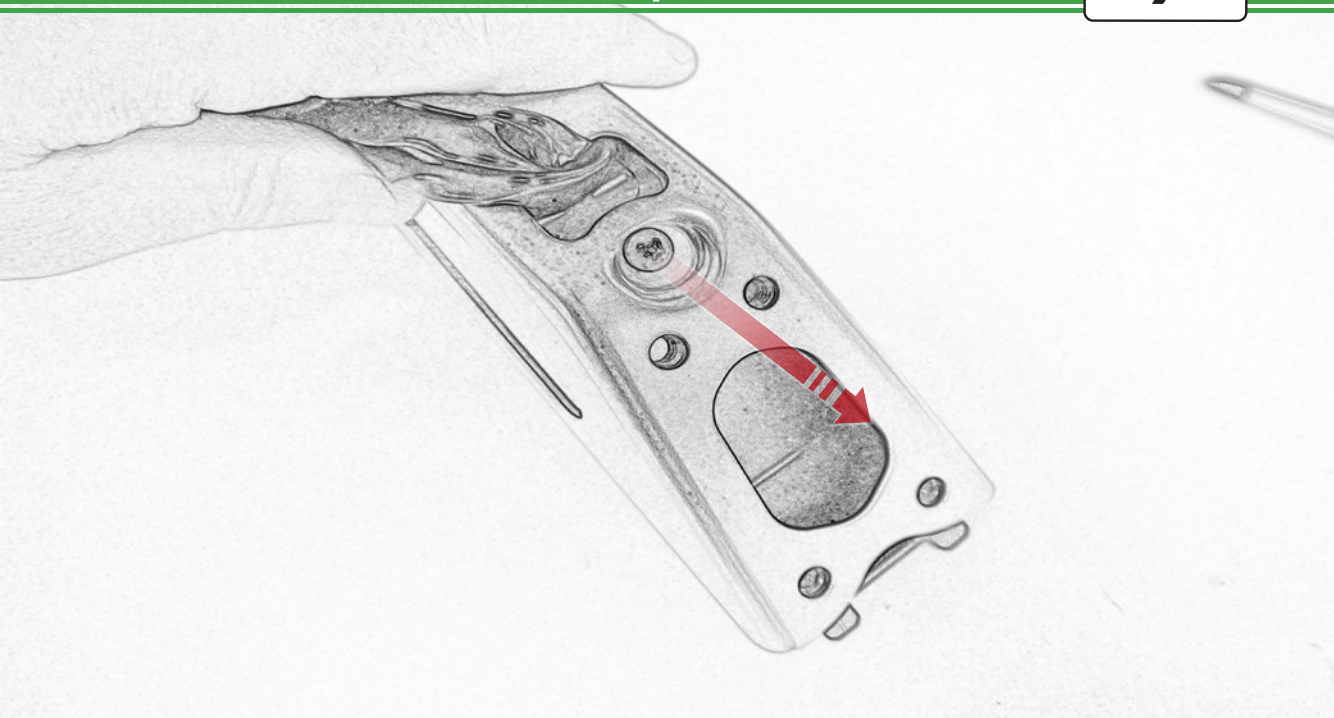

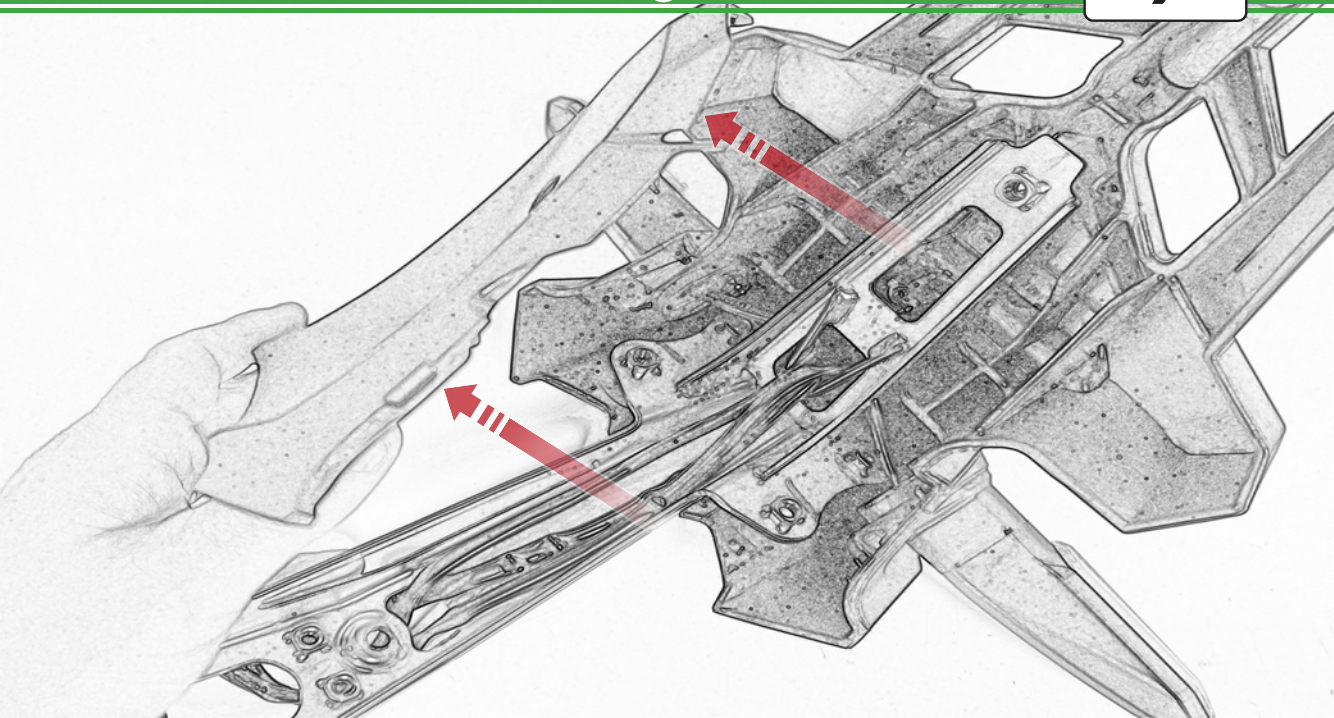

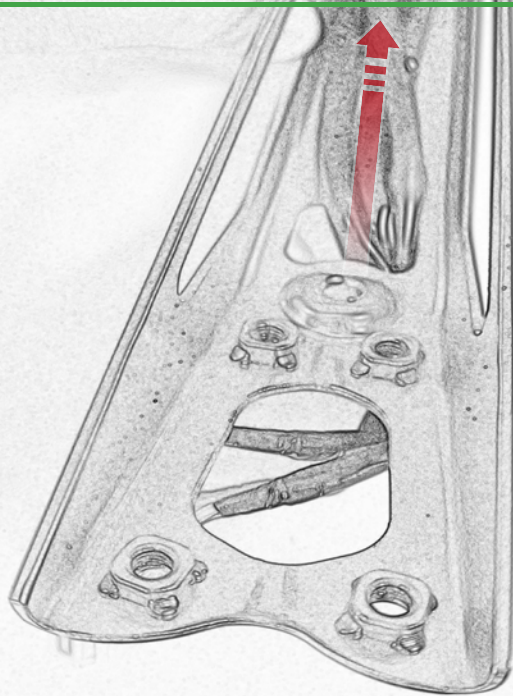

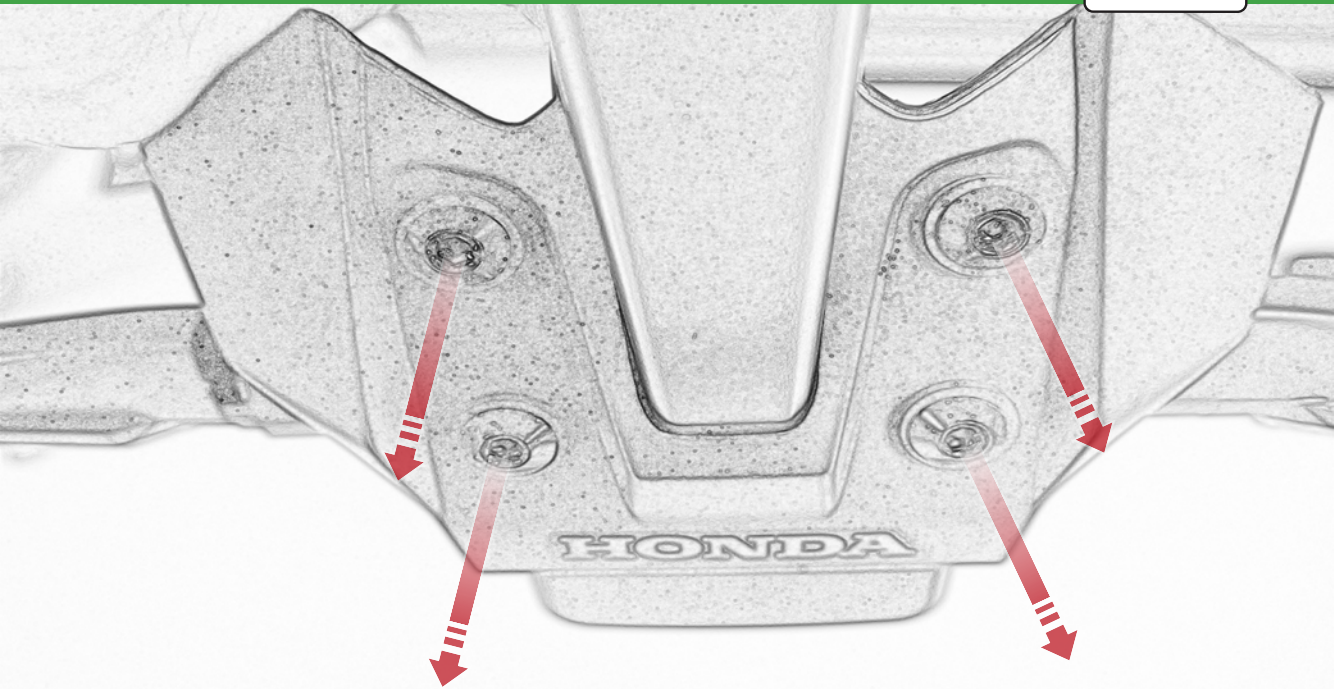

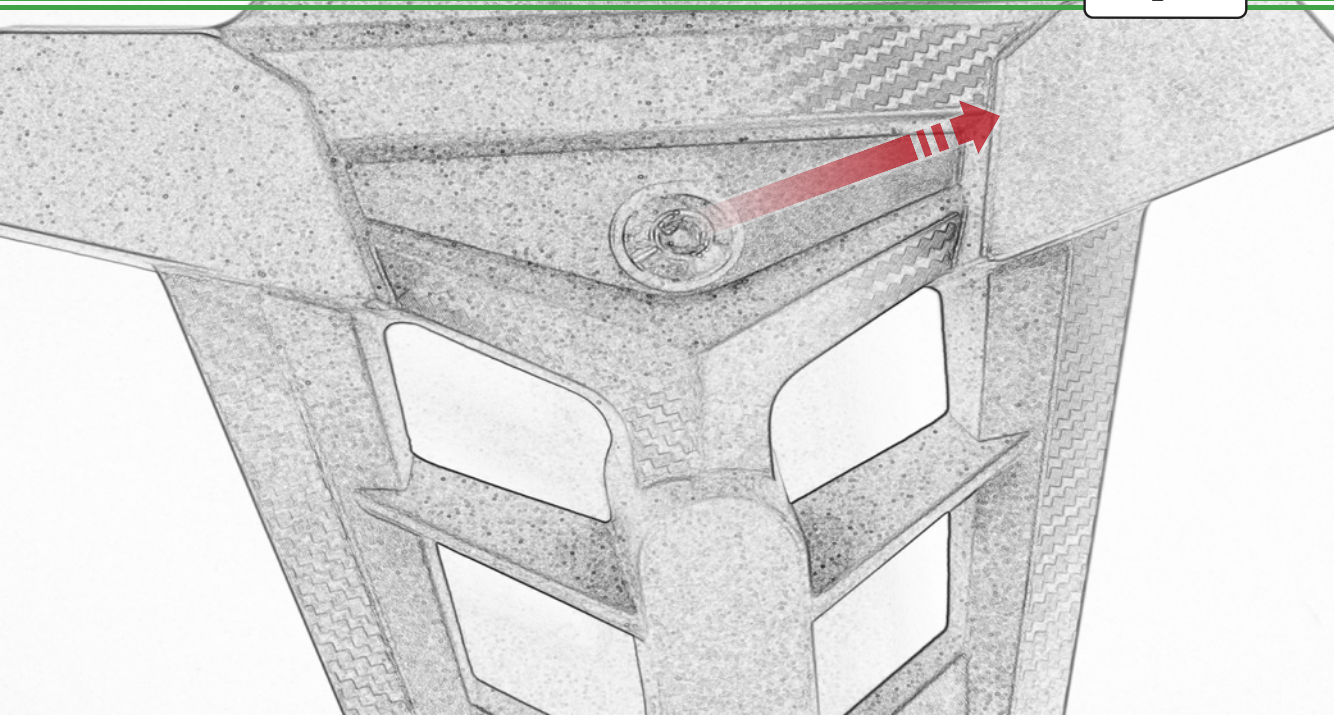

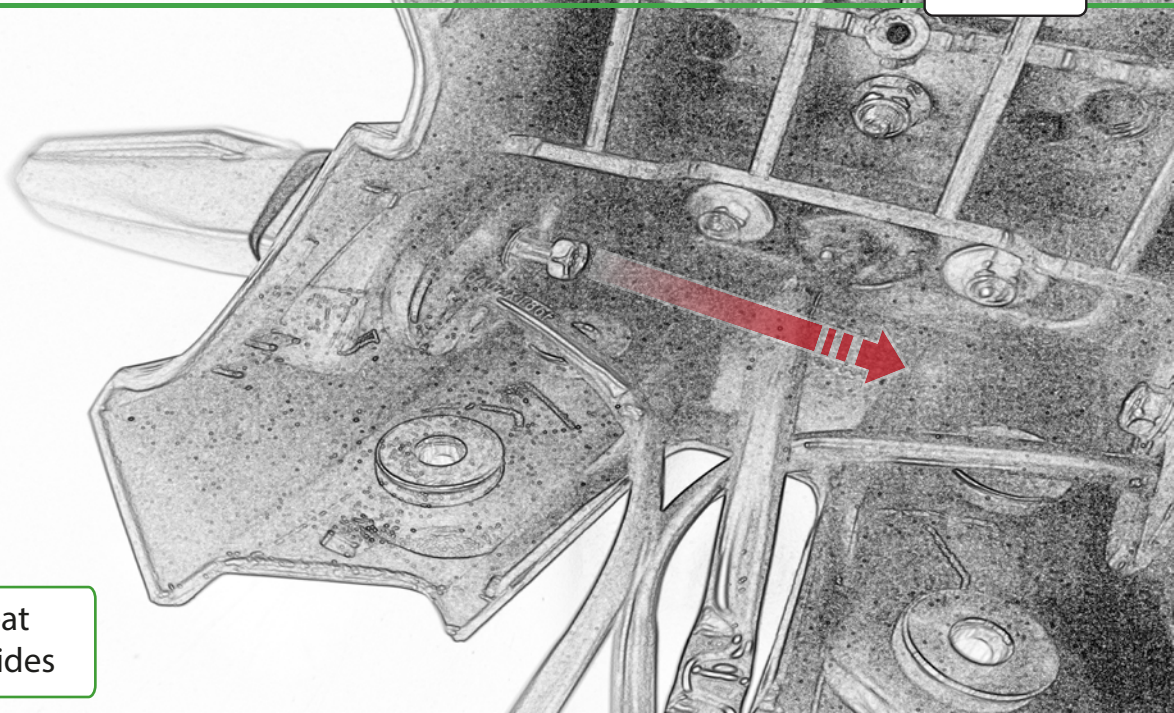

Repeat
Both Sides

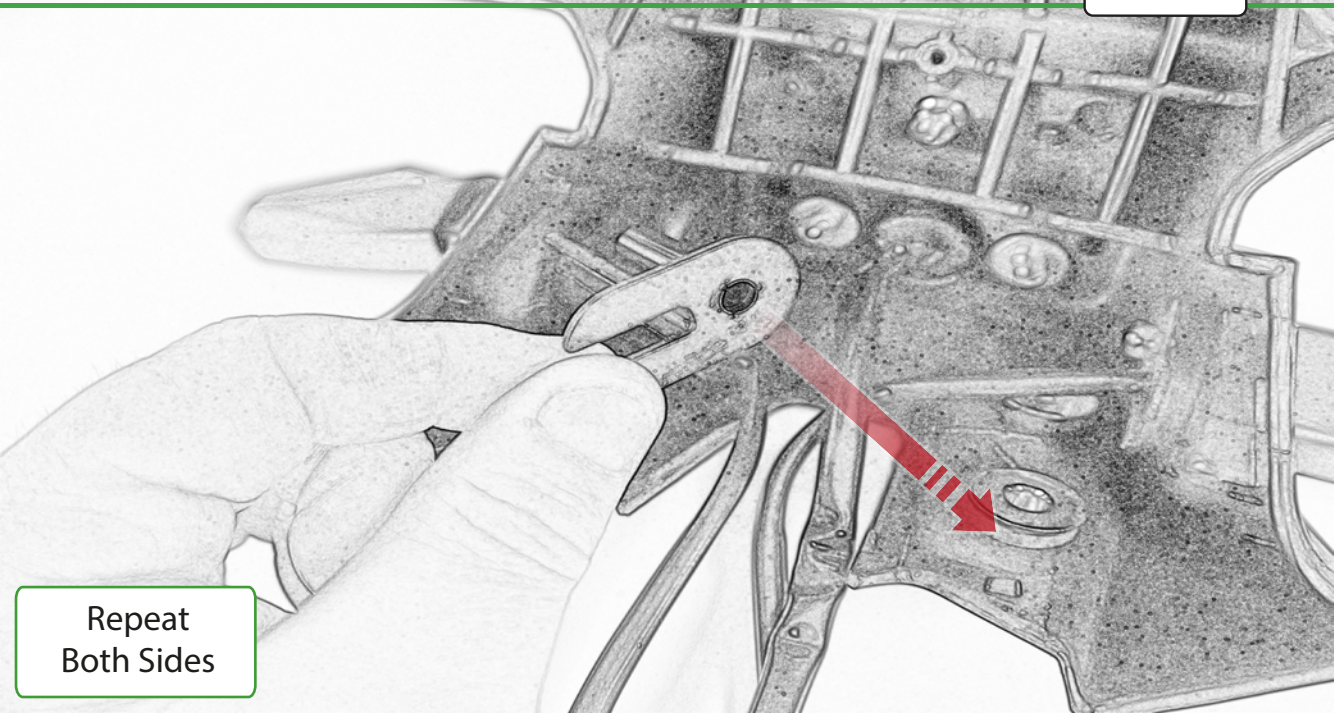

Repeat
Both Sides

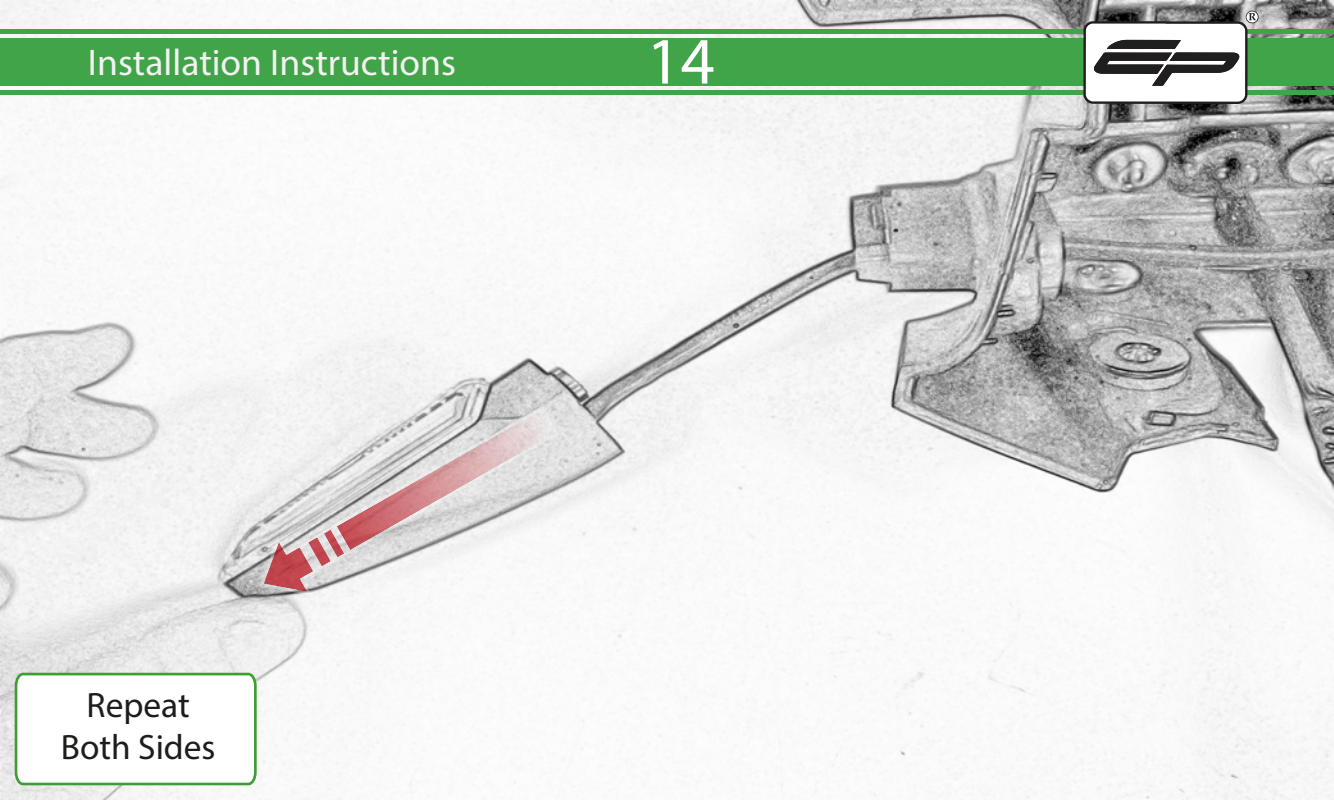

Repeat
Both Sides

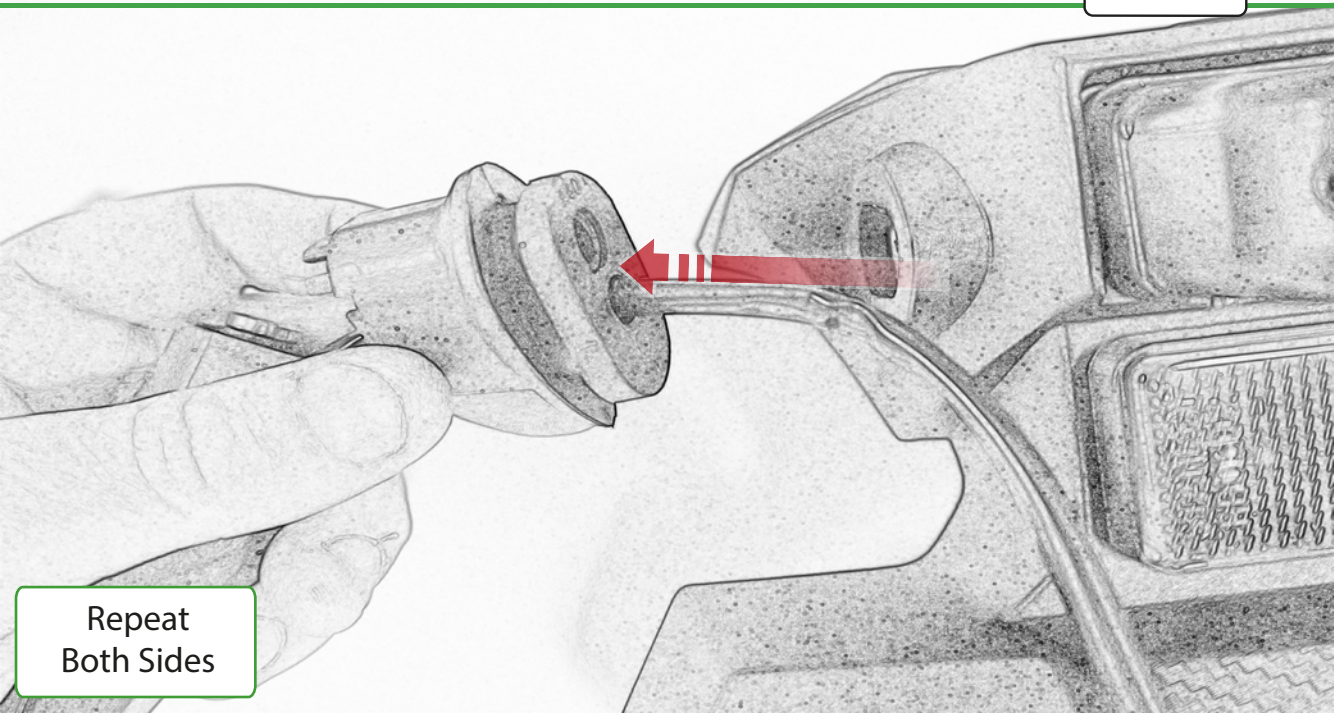

Repeat
Both Sides

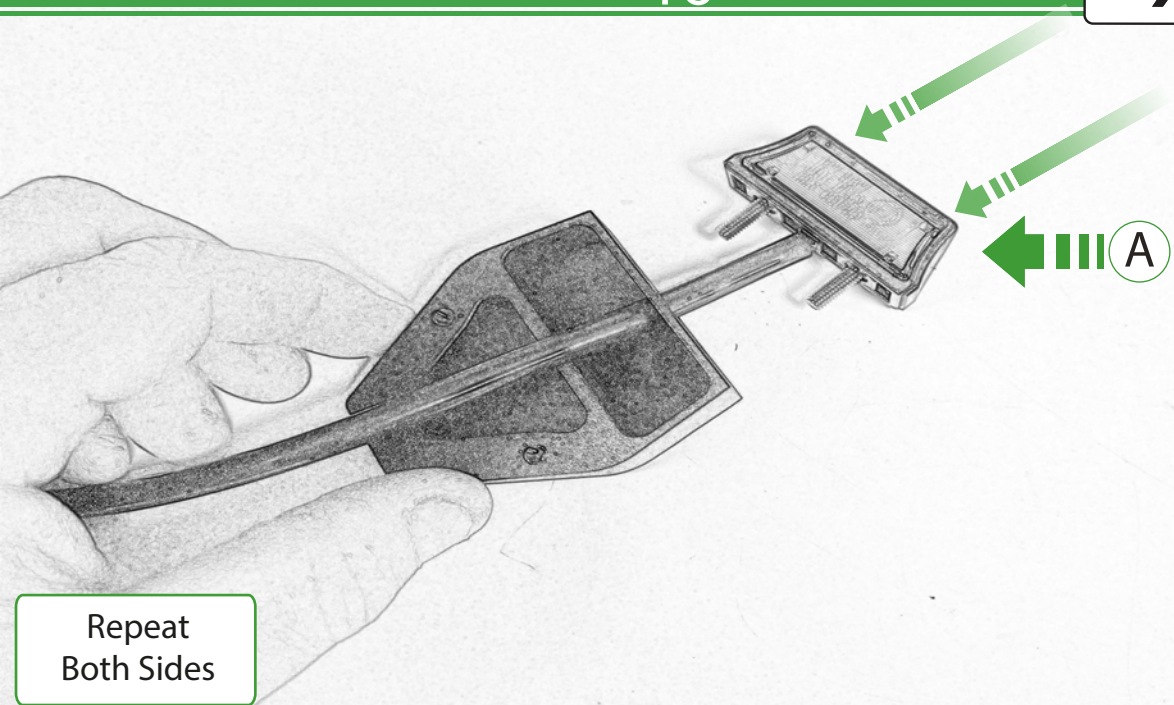

Repeat
Both Sides

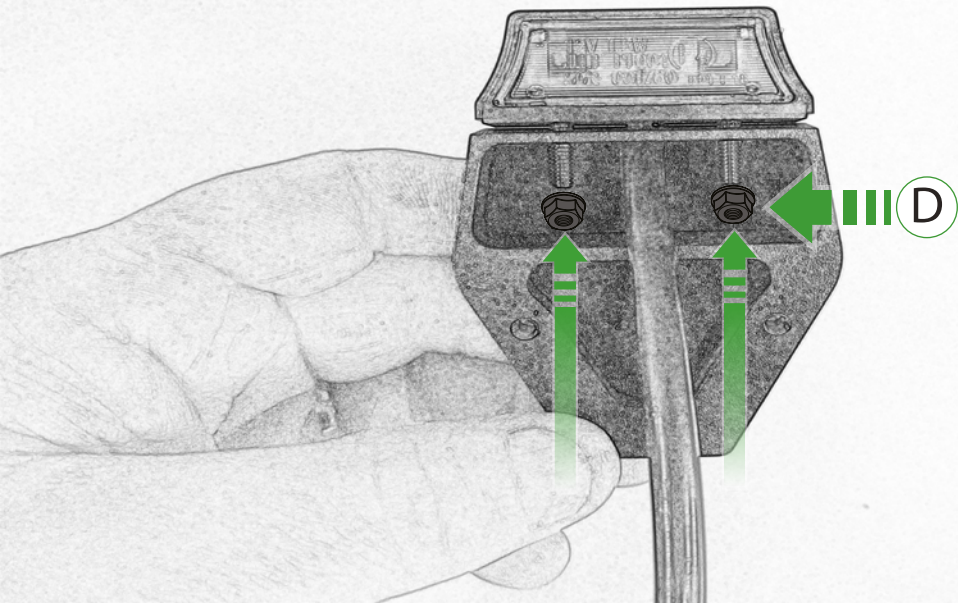

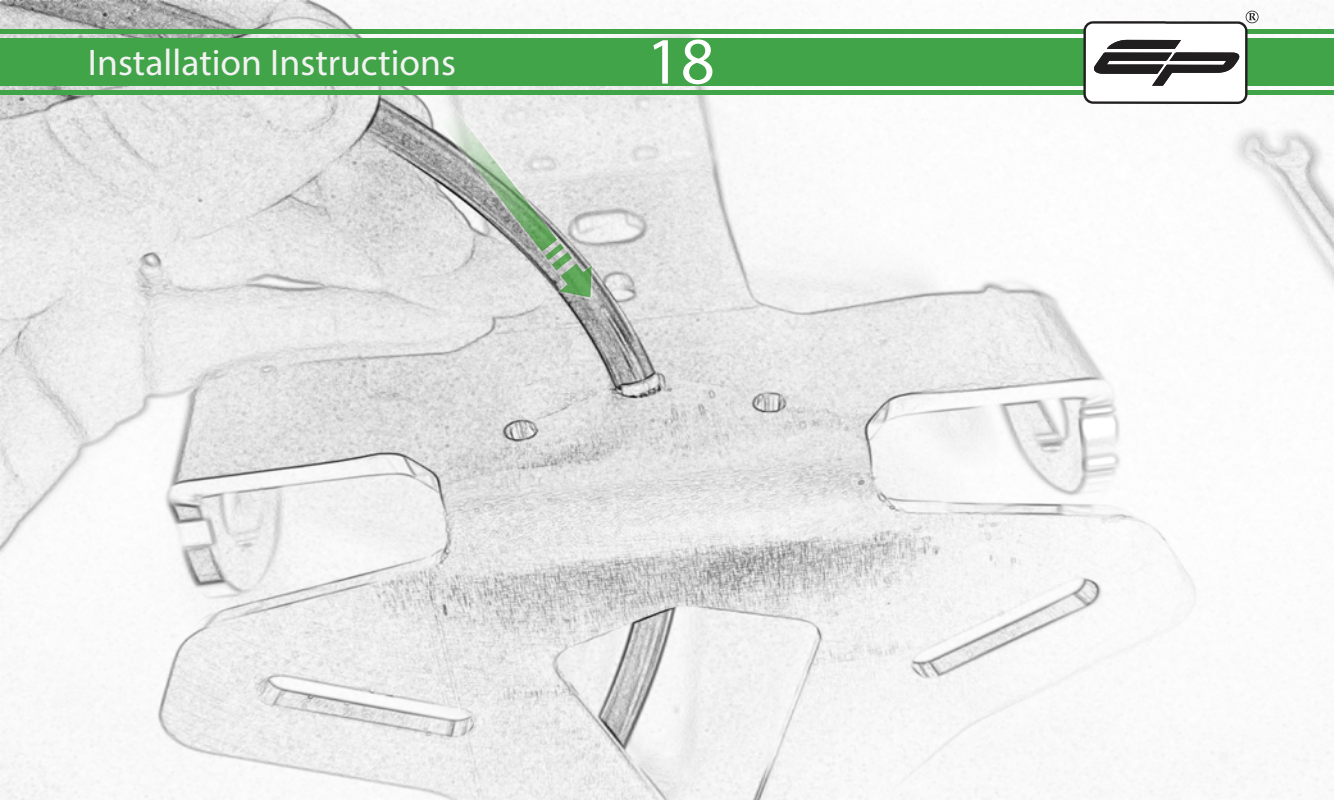

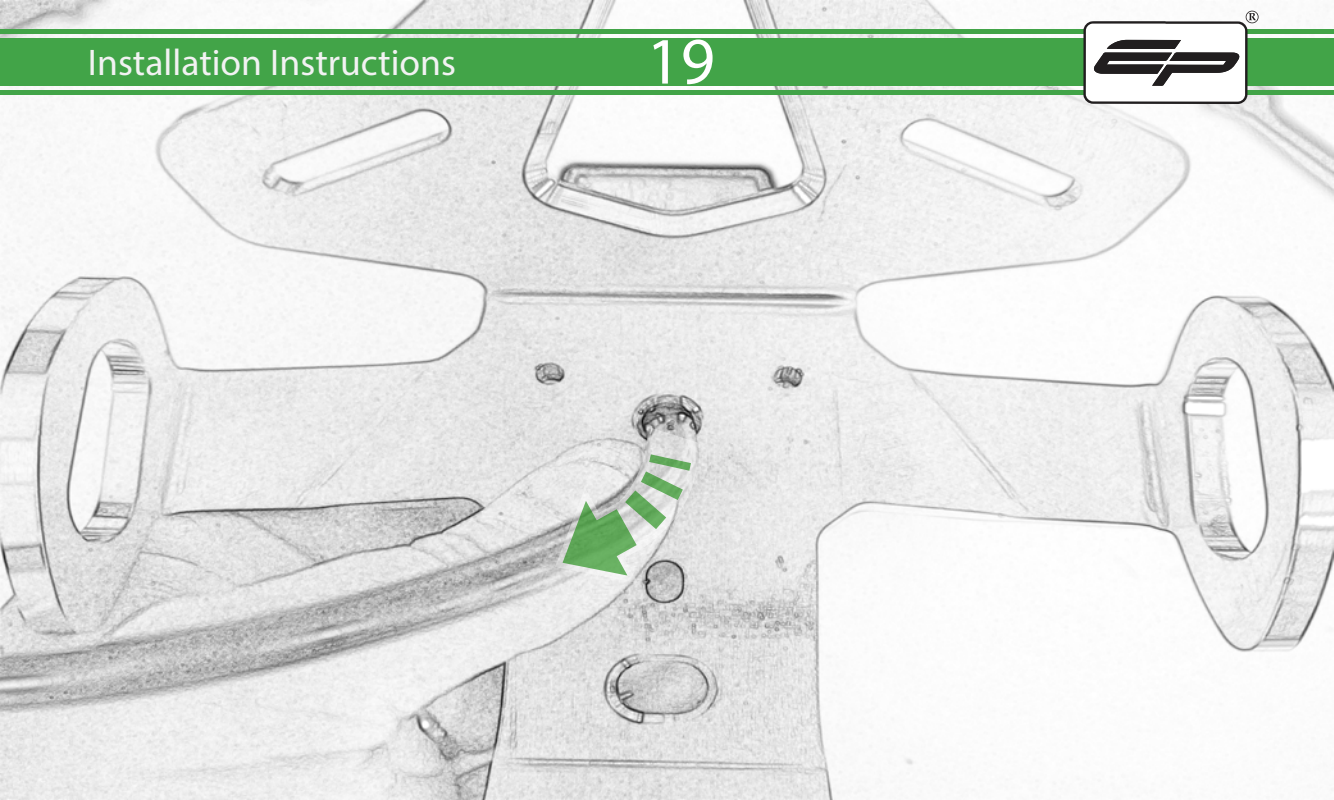

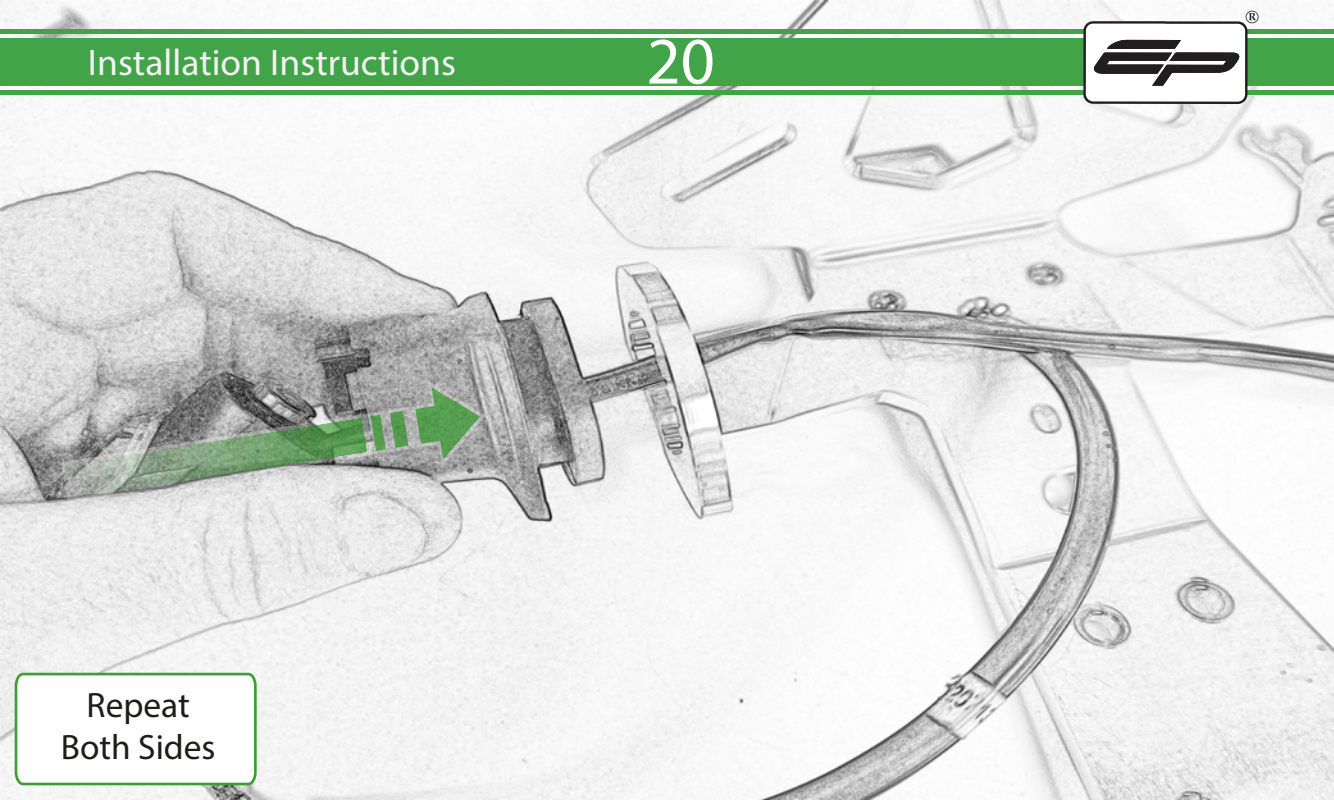

Repeat
Both Sides

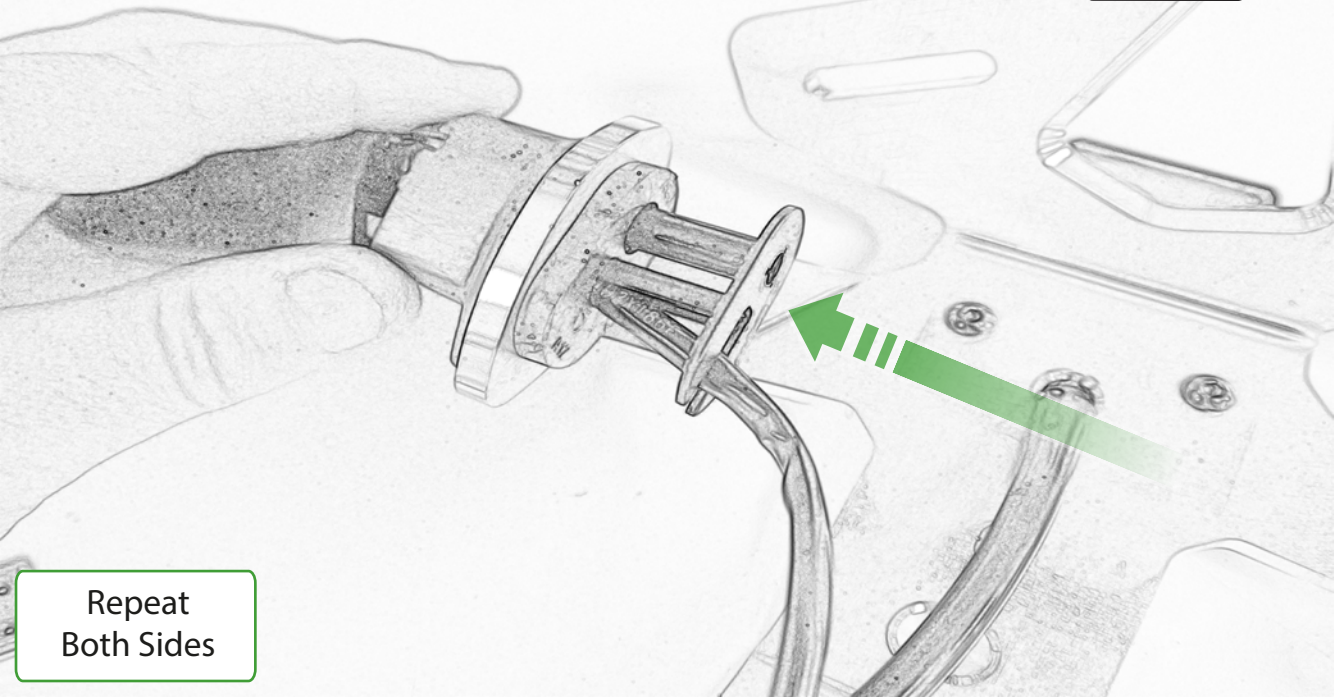

Repeat
Both Sides

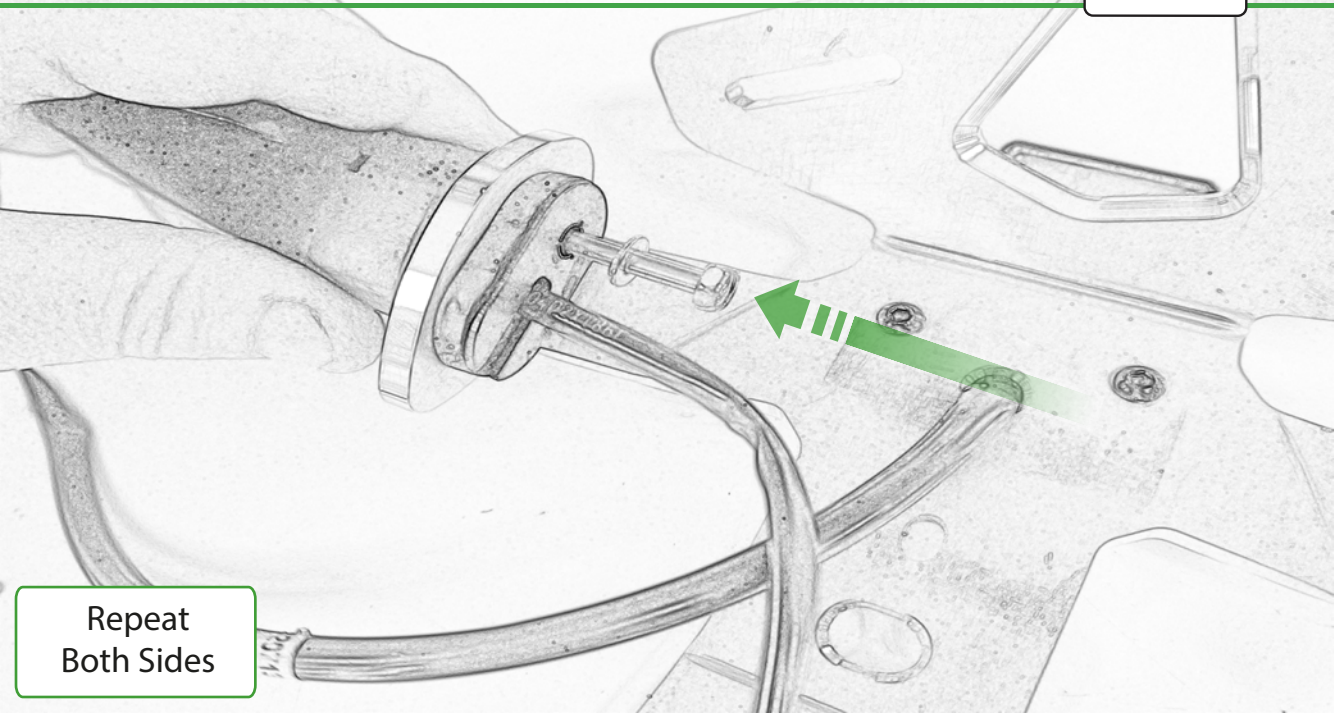

Repeat
Both Sides

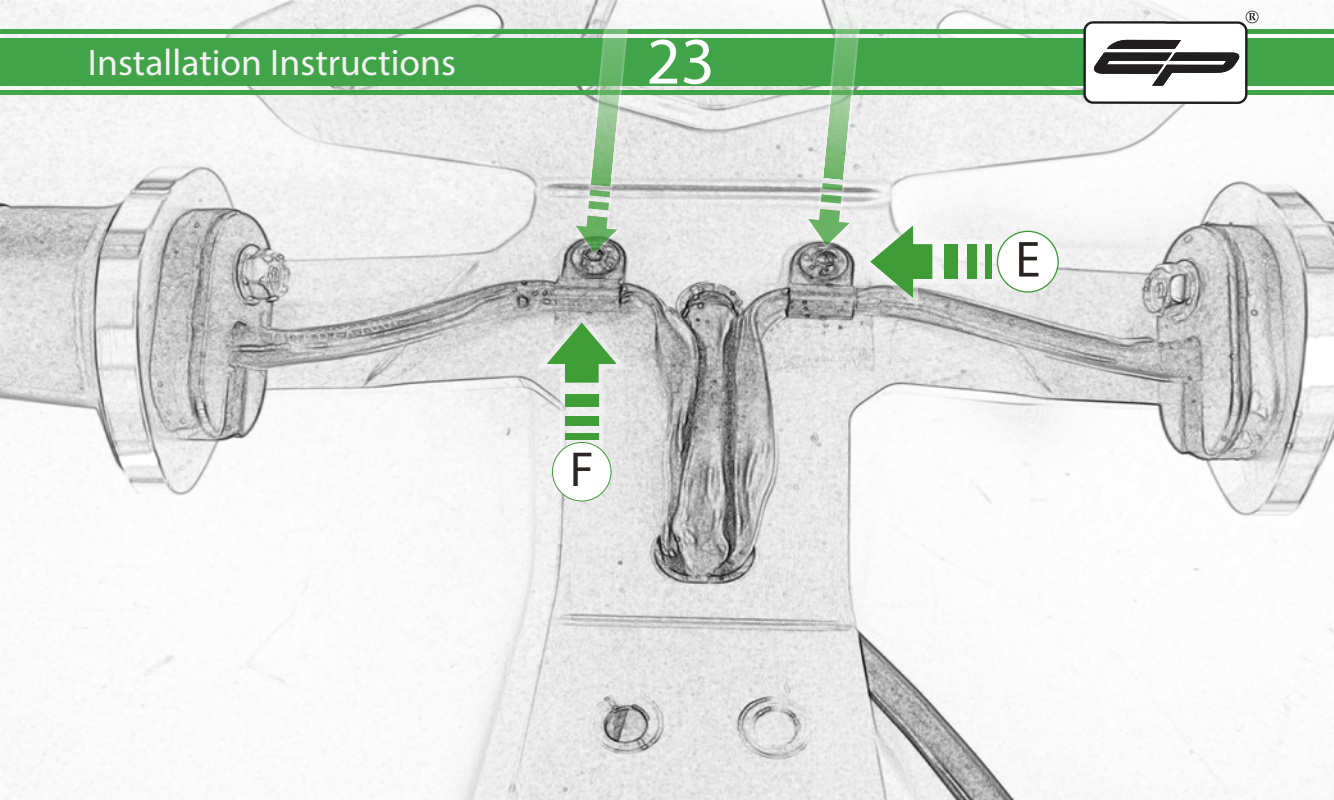

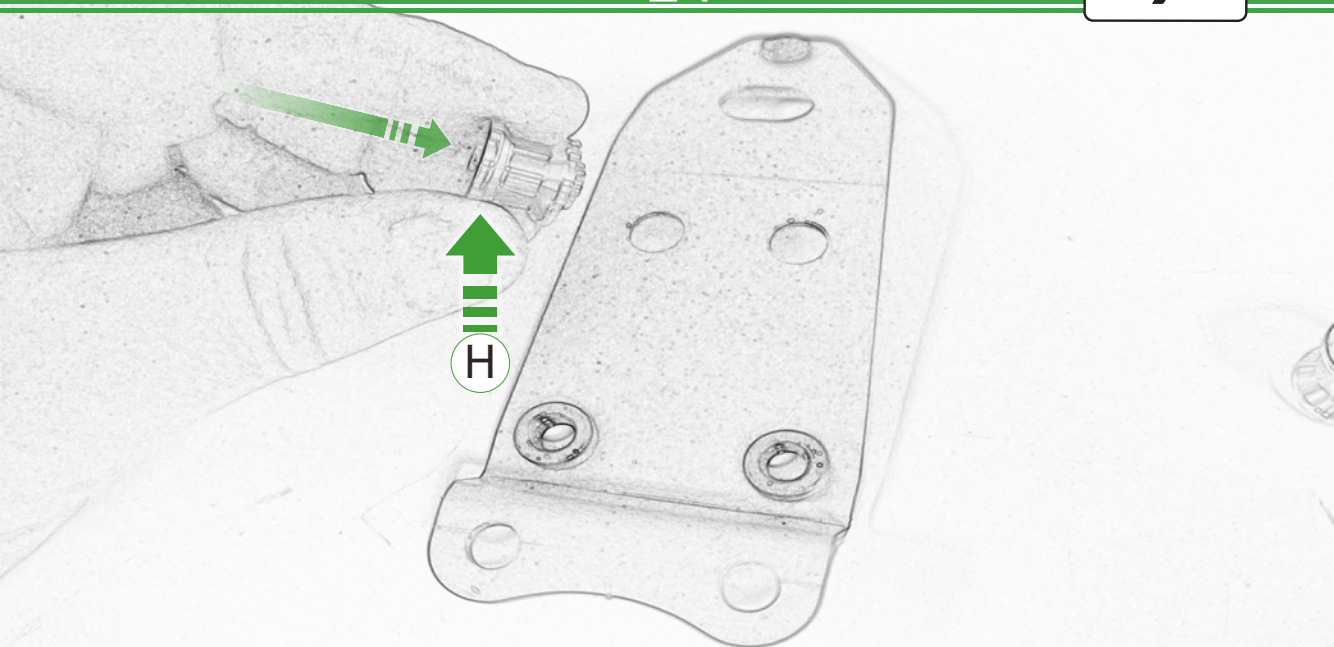

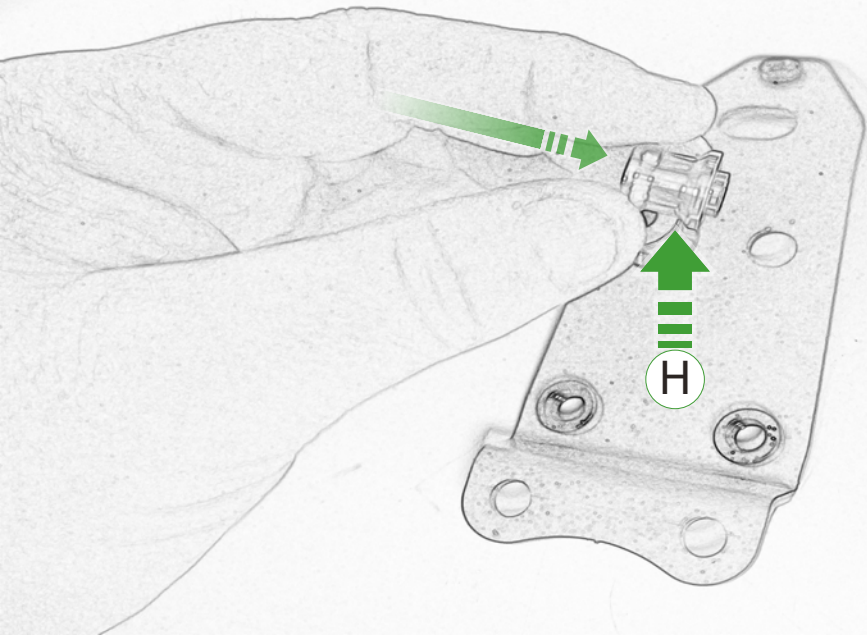

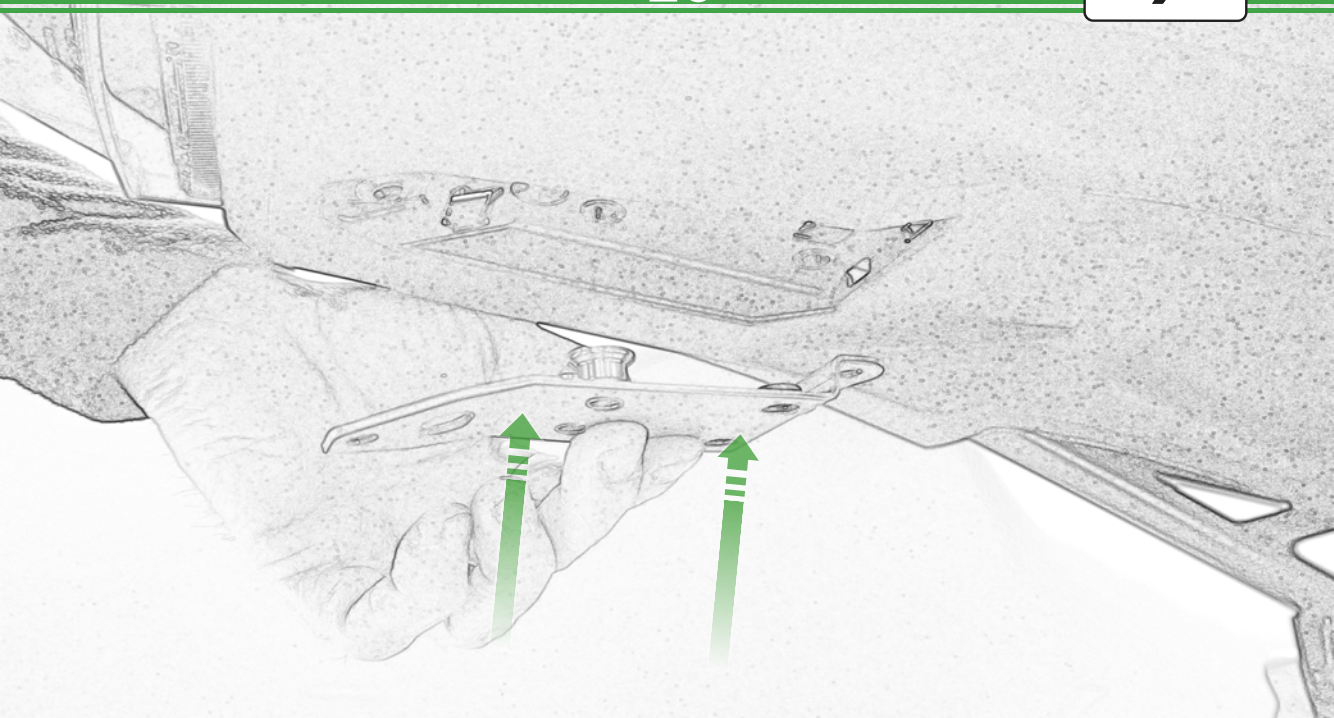

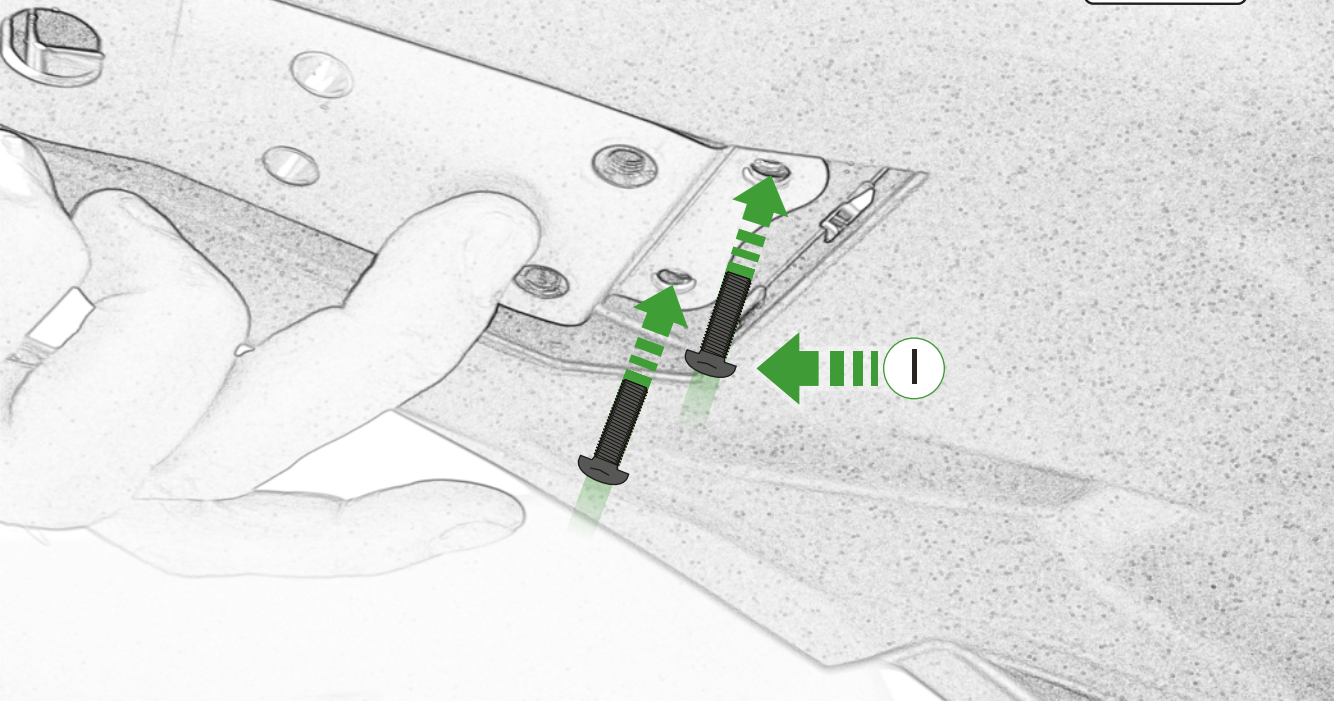

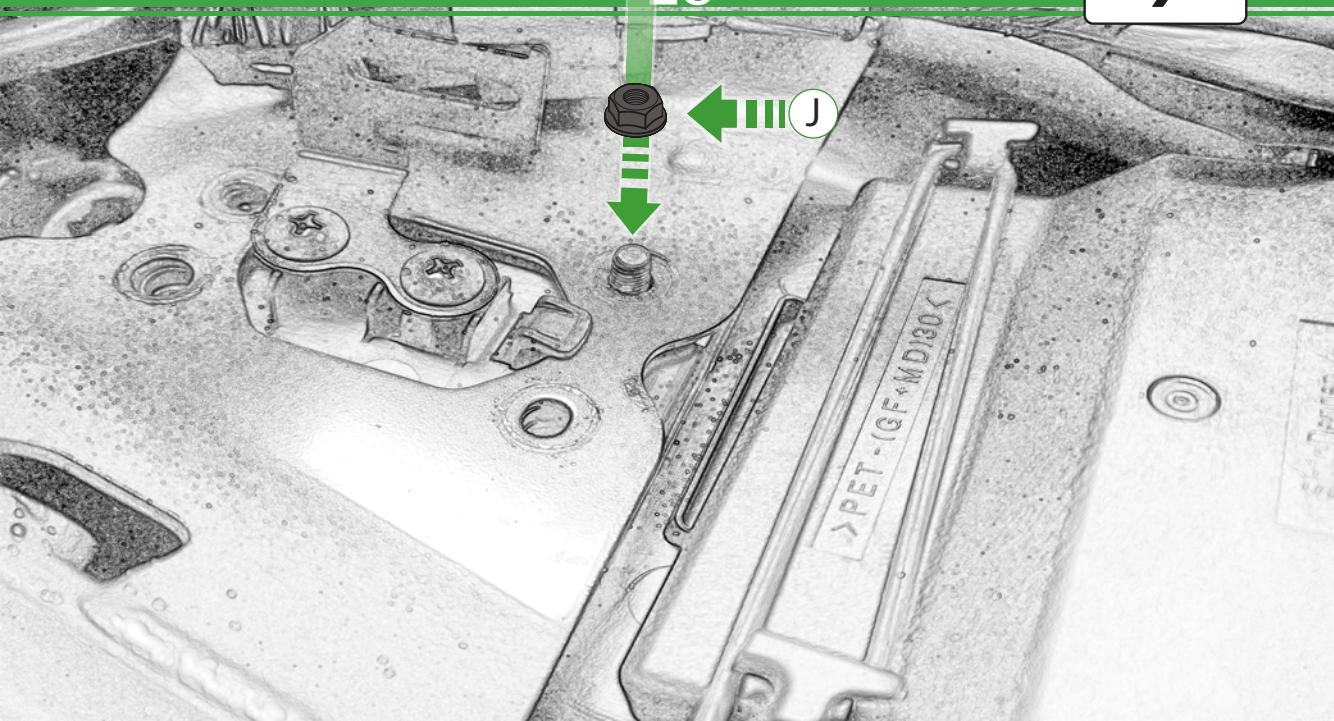

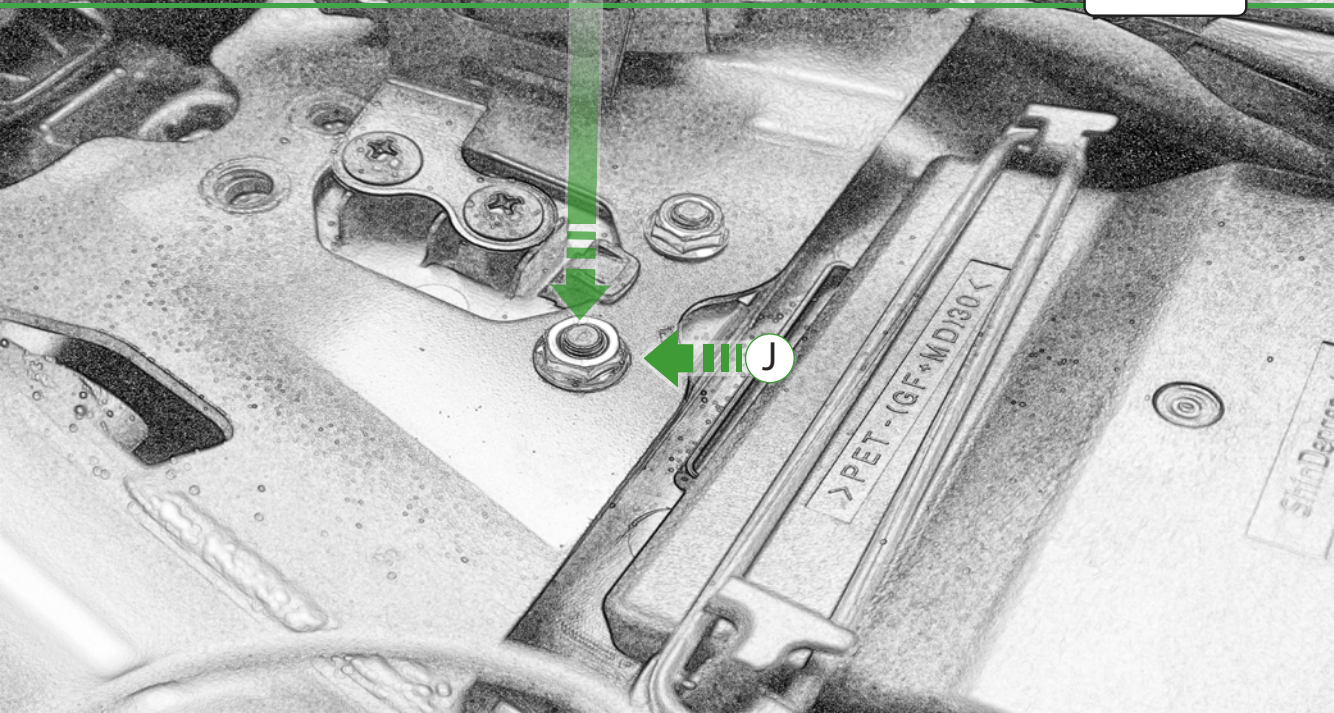

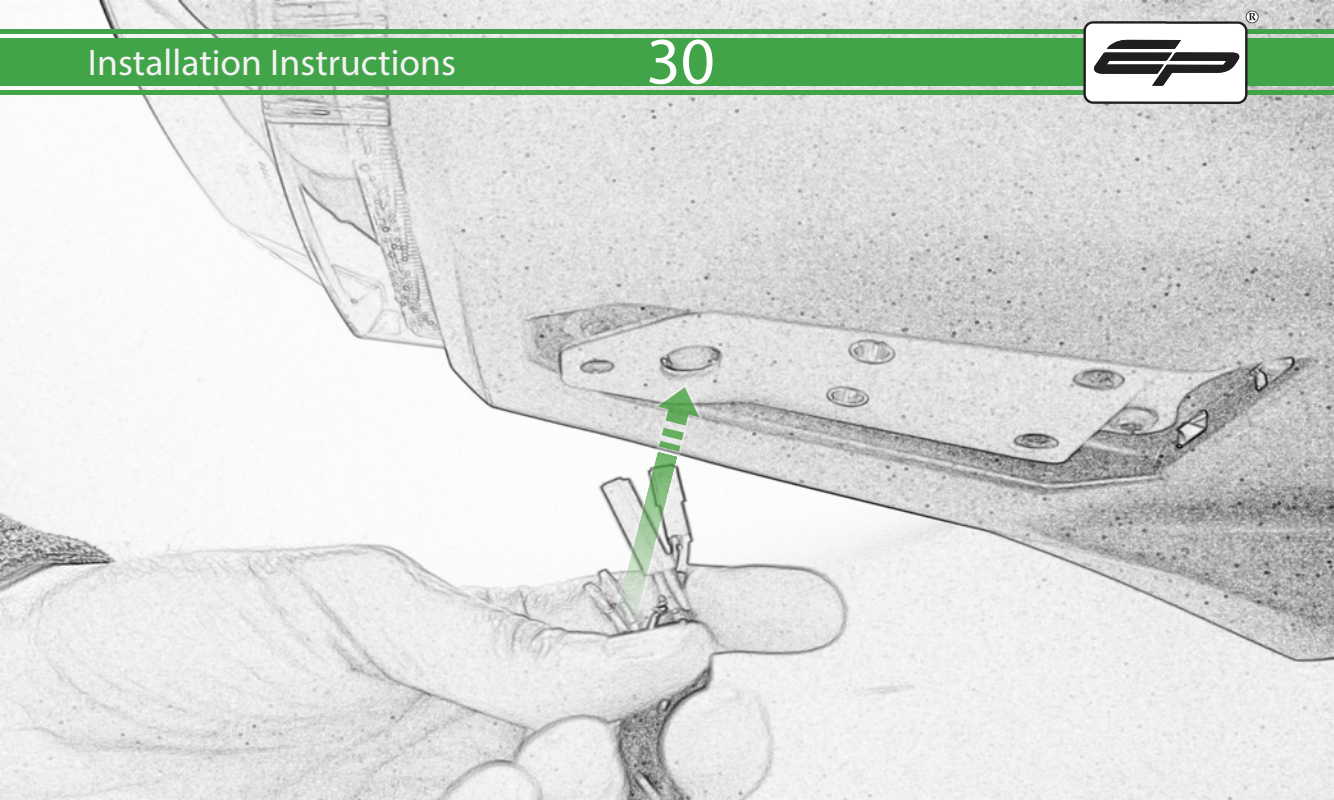



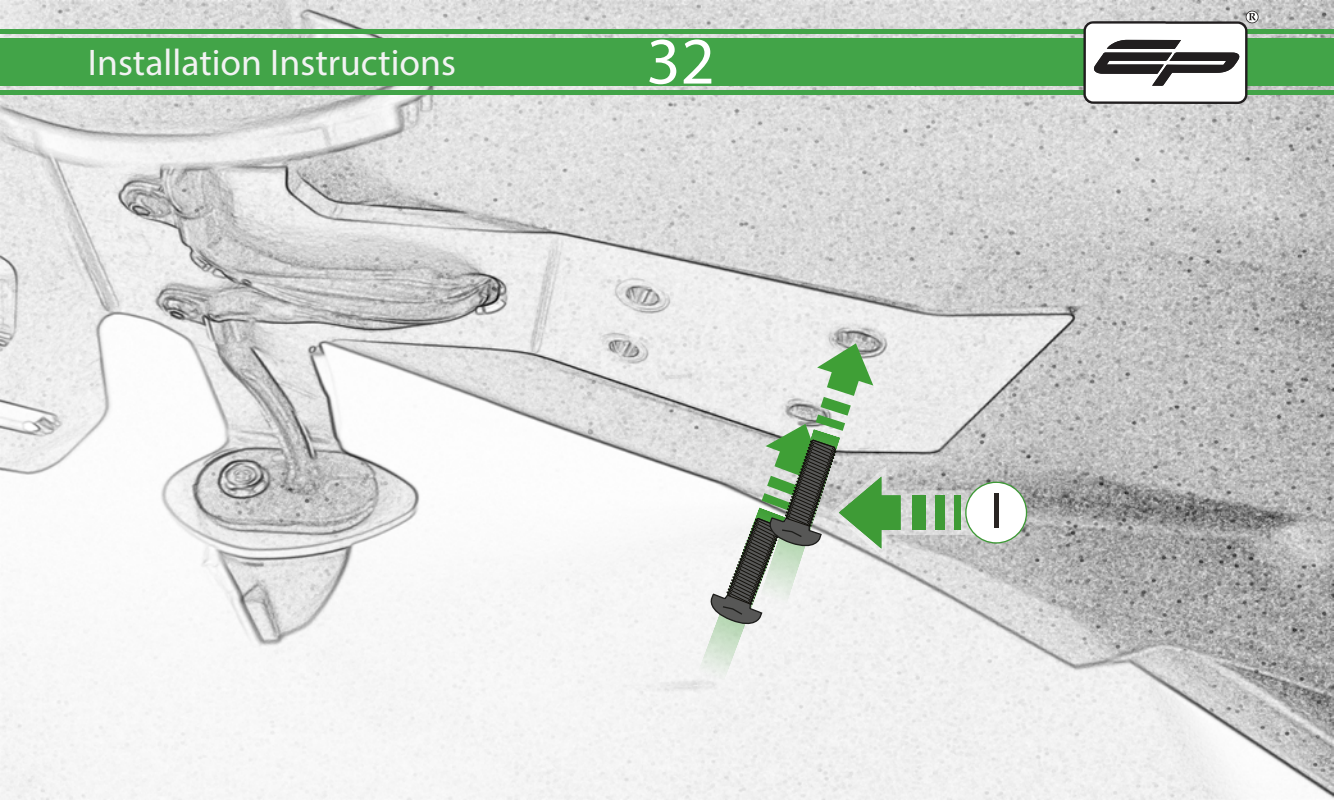

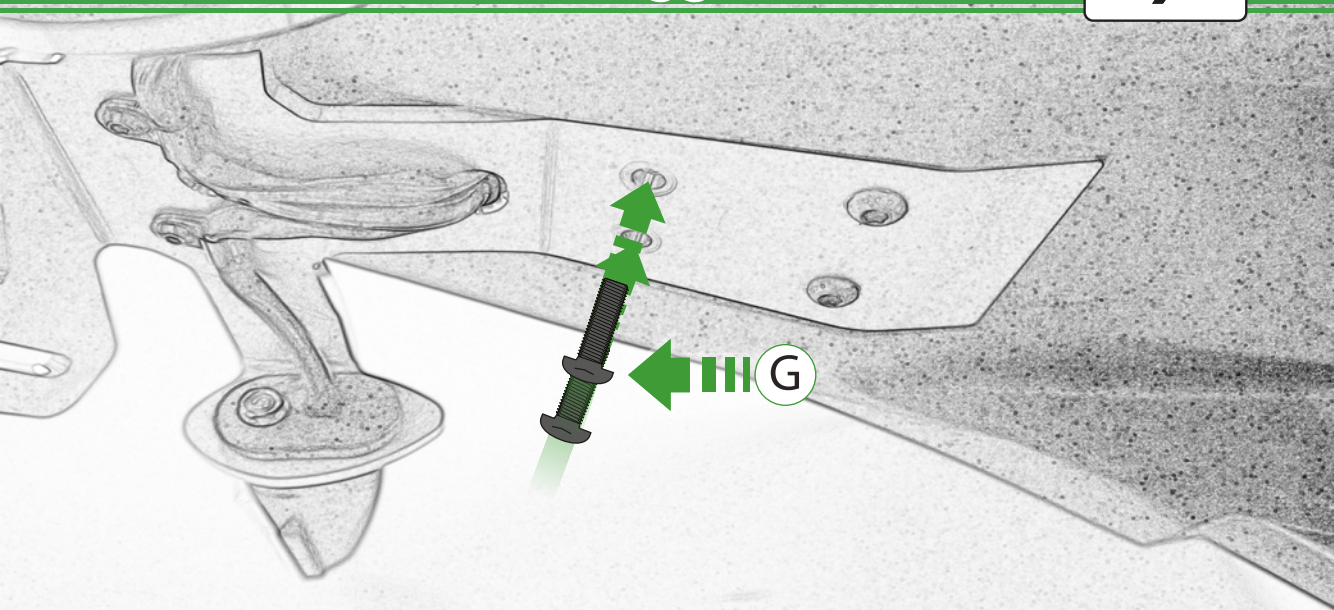

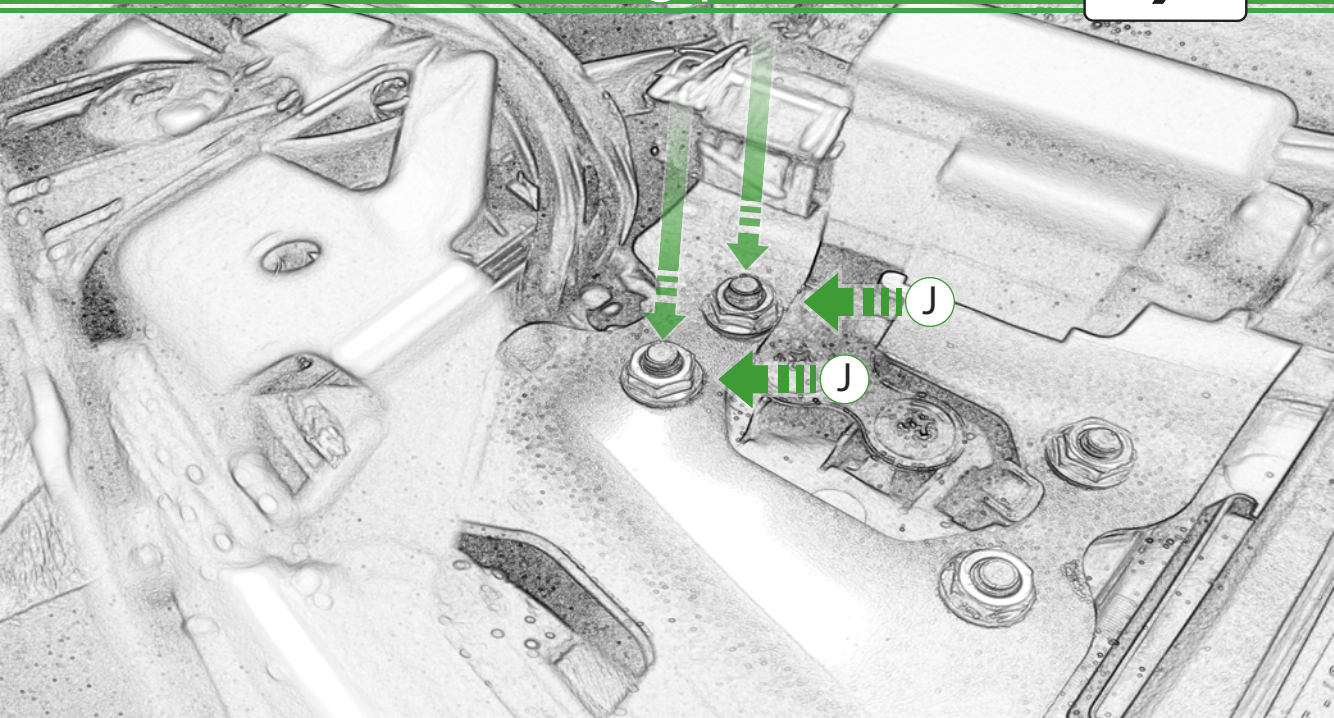

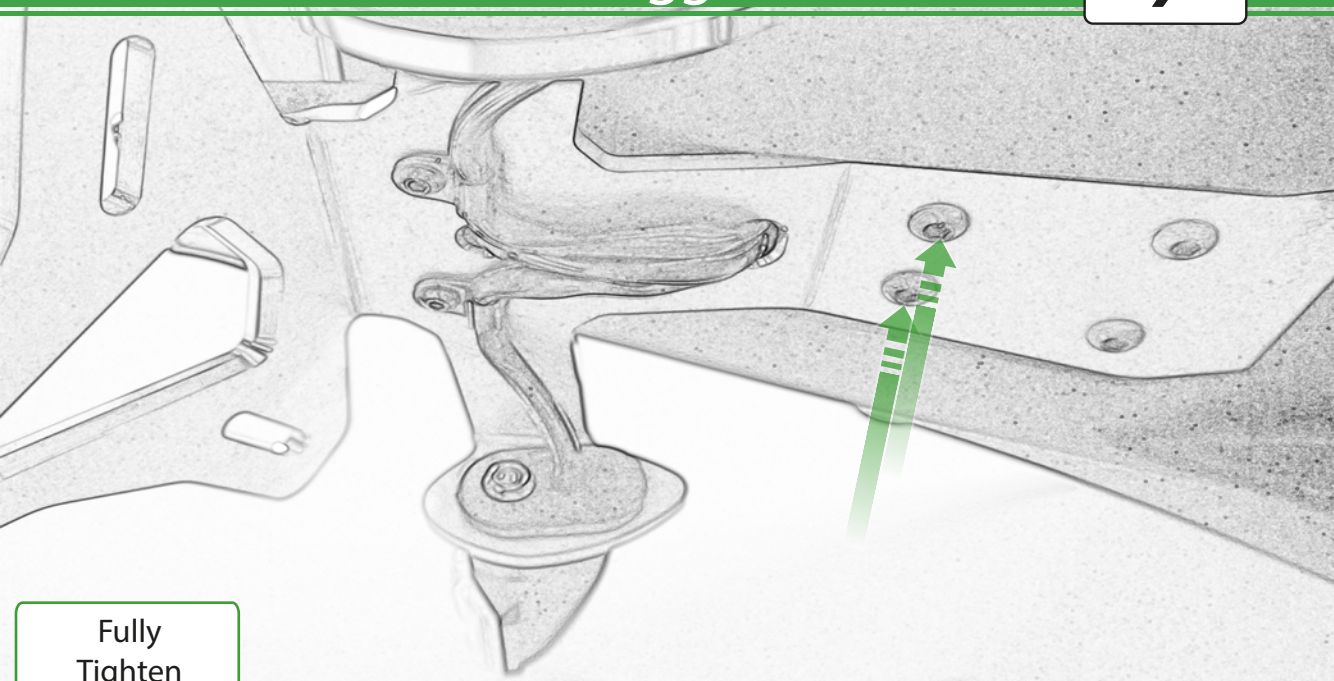

Fully
Tighten

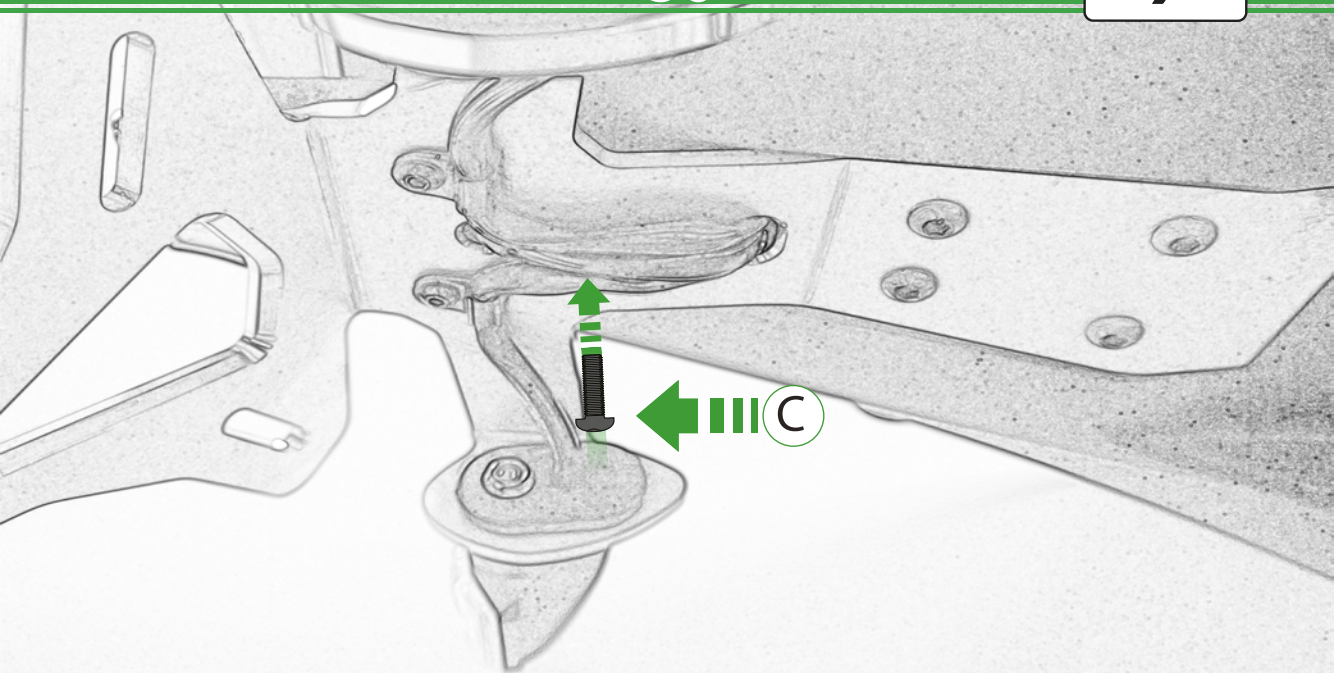



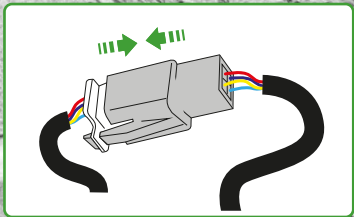
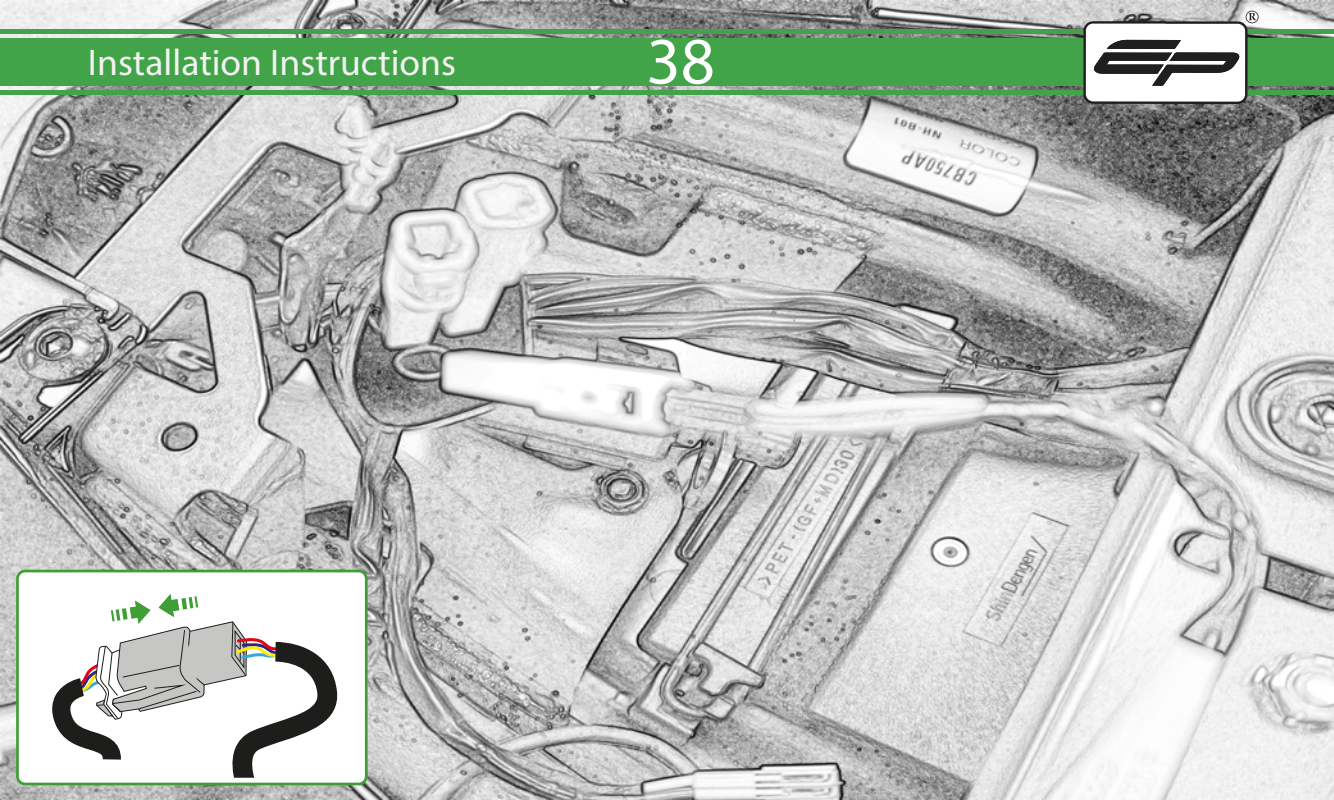

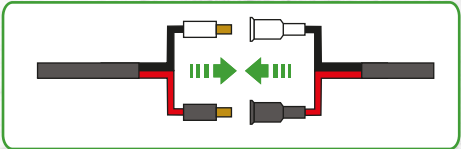
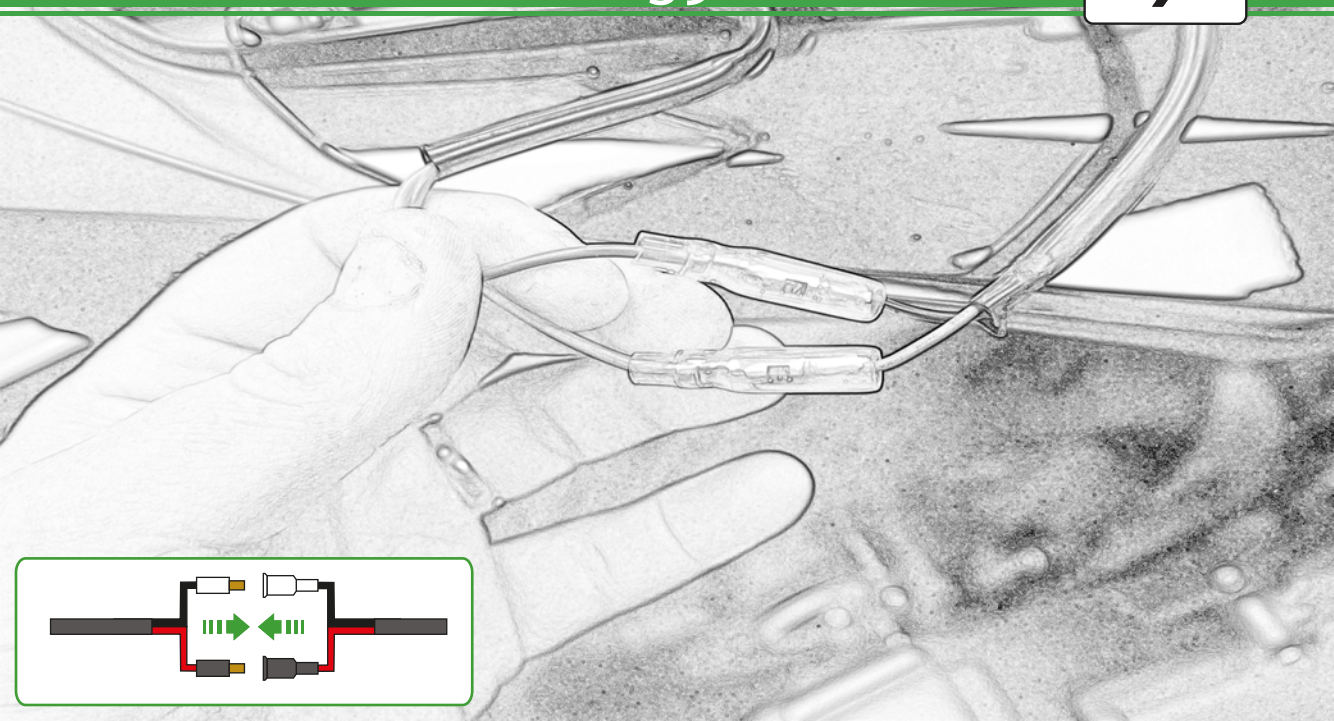



 **ESSENTIAL CHECKS** 

After installation of your tail tidy ensure that the licence plate does not contact the rear tyre when suspension is fully compressed.

Ensure all electrics including indicators, tail light, brake light and licence plate light lights are working correctly before riding the motorcycle.

It is recommended that periodic inspections are made to ensure that all fixings are fully tightend.

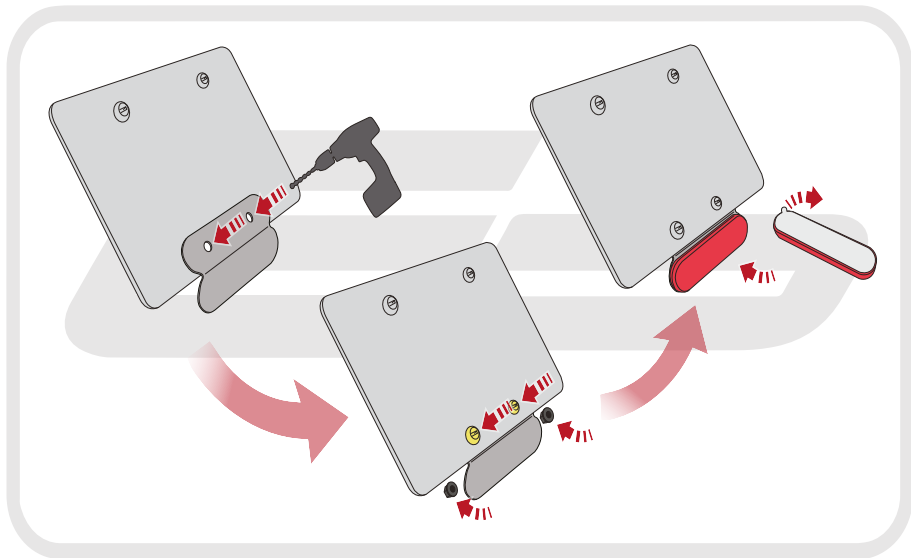

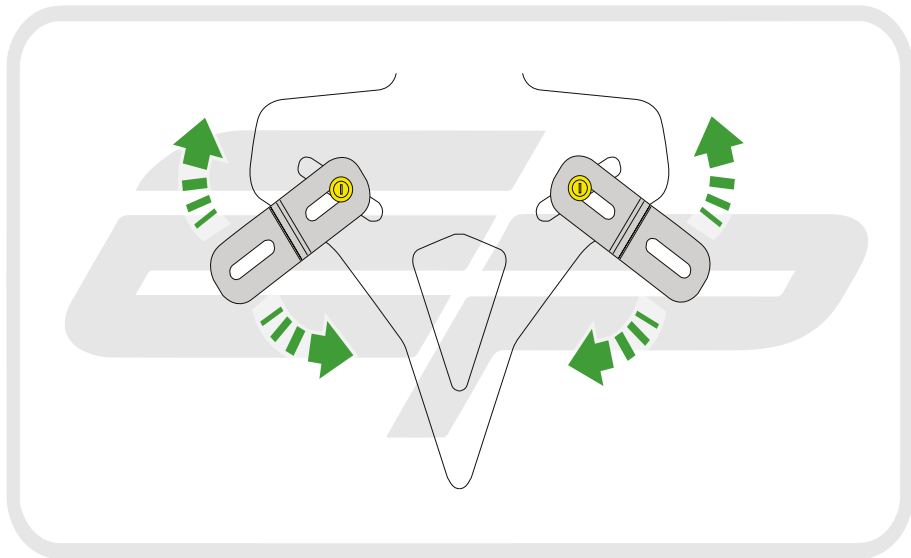



EVOTECH[®]
P E R F O R M A N C E

www.evotech-performance.com